



Platinum & Escape X 2026 Owner's Manual

Hydrotherapy to Heal Minds and Bodies™





Congratulations, You are now the proud owner of the finest spa built. Now you will experience true comfort and relaxation as you never had before. We at Cal Spas® focus on quality, design, and comfort to create a truly luxurious experience like no other. Welcome to the Cal Spas family.

It is important that you register your Cal Spas product as soon as possible. This can be done by taking a few minutes to complete an online registration form on our website. Allowing us to efficiently help you with parts, support, or other inquiries.

<https://calspas.com/register-your-spa.php>

Locating the Spa Serial Number

You will need your spas serial number, This serial number is placed on the exterior of the spa. The plate is placed on the lower right hand side when facing the front of the spa. This serial number is unique to your spa, and can be used to order parts, file a warranty claim, and is used in the registration process to activate your spas warranty.

Model: _____

Spa Serial Number: _____

Purchase Date: _____

Dealer's Phone Number: _____

Dealer's Address: _____

Copyright 2026 Lloyd's Material Supply Company, Inc. All rights reserved.
Duplication without written consent is strictly prohibited.
Cal Spas®, Adjustable Therapy System™, ATS™, Cal Premium™, Cal Select™, Cal Stone™, XL™ Heater, and Ultimate Fitness Spa Series™, are registered trademarks. Due to continuous improvement programs, all models, operation, and/or specifications are subject to change without prior notice.

LTR.2026.1010

3/16/2026 Rev E

Contact Information

For customer service or service technicians, please contact your authorized dealer immediately. If you need additional information and/or assistance, contact

**Lloyd's Material Supply Company, Inc.
Customer Service Department
1462 East Ninth Street
Pomona, CA 91766**

Toll Free: 1-800-CAL-SPAS

Fax: 1-909-629-3890

Table of Contents

Important Safety Instructions	4	Do's and Don'ts	51
Preparing for Your New Portable Spa	6	Bather Loads	52
Foundation Planning Requirements	7	Ozonator	52
240 Volt Electrical Installation	7	Troubleshooting Water Clarity	52
Removing Shipping Materials	8	Chemical Abuse	53
Clearance Requirements	9	Cal Salt Filtration Plus System (Option)	
Opening for Electrical Access	9	Introduction	54
Snap in Cabinet Panel Instructions	9	Important Salt System Information	55
GFCI Wiring Diagram for USA/Canada	12	Water Prerequisites	56
Filling and Powering Up the Spa	13	Fill Up Procedure	56
Priming the Pump	17	In.Clear Bromine Functions	59
Gecko in.k1000+ Control System		In.Clear on/off	59
How to Wake Up the Display	18	BromiCharge Levels	59
Start or Stop Accessories	19	Modifying boost Levels	60
Reading and Setting the Temperature	20	Modifying Maintenance Levels	60
Display Sleep Mode & Settings	21	Common Care & Troubleshooting	60
Water Care & Filter Cycles	22	Long Bromine Recovery Time	61
Water Care/Energy Modes	23	Low or No bromine detected	61
Reminders & Set Date and Time	24	Scale Removal/Cleaning Procedure	61
Keypad Settings Screen	25	Maintenance Level Information	61
Set Temperature Units	26	Water Lab (Option)	
Panel Lock & Unlock	27	Water Lab Information & Dimensions	64
in.touch Wifi		CO & EN Module Install Instructions	65
in.touch Wifi Set Up	28	Water Lab Probe Installation	66
in.touch App Guide	30	Maintenance & Calibration	67
Electrical Configuration (Technicians)	32	Logistics & Storage of Probe	68
Warm Weather (Thermal Creep)	33	Troubleshooting	69
Wifi Connection (Post-in.touch installation)	33	Cleaning and Maintenance	
Error Messages and Trouble Codes	34	Removing & Re-seating Pillows/Jets	70
Spa Operations		Cover & Locking System for Platinum Spas ...	71
Electrical Power Efficiency Tips	35	Cover & Locking System for Escape X	73
Jets and LED Lighting	35	Draining Your Portable Spa	77
Diverter, Air Venturis, and Waterfalls	36	Winterization (Cold Climate Draining)	78
ATS Therapy Seat System (Option)	37	Cleaning and Replacing the Filter	78
Throttle Seat Variable Speed (Option)	38	Vacation Care	78
Water Clarity		Cleaning Your Spa	79
The Four Steps for Water Clarity	42	Using the Freedom Sound System	79
Water Quality Terms and Definitions	43	Appendix	
Water Testing Methods	44	Ordering Replacement Parts	80
Adding Chemicals to the Spa	44	Replacement Parts	81
Balancing Water Chemistry Levels	45	Basic Troubleshooting	87
Sanitation and Shock	46	Warranty Information	91
Filtration and Cleaning	48		
General Water Care Schedule	49		
Generic Names for Chemicals	49		
Common Water Chemistry Questions	50		

IMPORTANT SAFETY INSTRUCTIONS



READ AND FOLLOW ALL INSTRUCTIONS CAREFULLY

When using and installing this spa, basic safety precautions should always be followed, including.



Danger: RISK OF SEVERE INJURY OR DROWNING!

- NO DIVING, diving may result in injury or death.
- Do not allow children to be in or around the spa unless a responsible adult supervises them.
- Keep the spa cover on and locked when not in use
- See instructions enclosed with your cover for locking procedures.



Danger: SUCTION ENTRAPMENT HAZARD, RISK OF SEVERE INJURY OR DROWNING!

Suction in suction fittings when broken, damaged, cracked, or unsecured can cause severe injury and or death due to the following entrapment hazards.

- **Body Entrapment:** A negative pressure applied to a large portion of the body or limbs can result in entrapment.
- **Hair Entrapment:** Hair can be sucked in or caught within the suction fitting.
- **Evisceration/Disembowelment Entrapment Risk:** Negative pressure applied directly to the intestines through a damaged/unprotected suction outlet. This can result in Evisceration/Disembowelment.
- The suction fittings in this spa are sized to match the specific water flow created by the pump. Should the need arise to replace the suction fittings, or the pump, be sure the flow rates are compatible.
- The suction fitting is made with chemical resistant plastic, that will last over a finite period of time. This component will degrade and become brittle after constant exposure to sanitizers. When performing maintenance on the spa, inspect suction fittings for any cracks or damage.
- When the spa is in operation, suction is created within the suction fittings. Persons within the spa should not be leaning on, stepping on, or making contact with suction fittings.



Danger: RISK OF SEVERE INJURY FROM ELECTRIC SHOCK OR DEATH FROM ELECTROCUTION.

- Install the spa at least 5 feet (1.5 meters) from all metal surfaces. As an alternative, a spa may be installed within 5 feet (1.5 meters) of metal surfaces if each metal surface is permanently bonded by a minimum of 8 gauge AWG solid copper conductor to the outside of the spas control box.
- DO NOT permit any external electrical appliances, such as lights, telephones, radios, television, etc, within 5 feet (1.5 meters) of the spa. Never attempt to operate any electrical device from inside the spa.
- Replace any damaged power cord immediately.
- Never bury any power cord, a proper conduit must be used.
- Connect to a proper grounding-type receptacle or to a proper grounding post in the GFCI and breaker.



Warning: RISK OF HYPERTHERMIA (OVER-HEATING) CAUSING SEVERE INJURY, BURNS, WELTS, OR DEATH

- Water temperature in excess of 104°F (40°C) may be detrimental for your health.
- The spa water should never exceed 104°F (40°C). Water temperatures between 100°F (38°C) and 104°F (40°C) are considered safe for a healthy adult.
- Lower water temperatures are recommended for young children, and when the spa use exceeds 10 minutes.
- Before using the spa, the user should measure the water temperature since the tolerance of water temperature regulating devices varies.
- **Do not use the spa if drugs, alcohol, or prescription medications were consumed before or during use. In an altered state of mind, the human body can not react properly to changes in temperature. This increases your risk of hyperthermia, injury, drowning, or death.**

 **Warning: REDUCE RISK OF HEAT RELATED INJURY OR DEATH**





- Prolonged exposure to hot air or water can induce hyperthermia. Hyperthermia occurs when the internal temperature of the body reaches a level between 3°F (2°C) to 6°F (4°C) above the normal body temperature of 98.6°F (37°C). While using warm spa water has many health benefits, its important to make sure that your body's core temperature does not rise above 103°F (39.5°C).
- High water temperatures have a high potential for causing fetal damage during pregnancy. Women who are pregnant, or think they are pregnant should always check with their physician prior to spa usage.
- The use of alcohol, drugs or medication before or during spa use may lead to unconsciousness, with the possibility of drowning.
- Persons suffering from obesity, a medical history of heart disease, low or high blood pressure, circulatory system problems or diabetes should consult a physician before using the spa.
- Persons using medications should consult a physician before using the spa since some medications may induce drowsiness or impair judgment. Other medications or drugs may affect heat rate, blood pressure and circulation.

 **HYPERTHERMIA**

- Symptoms of excessive hyperthermia include dizziness, lethargy, drowsiness and fainting. The effects if excessive hyperthermia may include:
 - Failure to perceive heat
 - Failure to recognize the need to exit the spa
 - Unawareness to impending hazards
 - Fetal damage to pregnant woman
 - Physical inability to exit spa
 - Unconsciousness

 **Swim Spa Temperatures**

- When using a swim spa or deck spa for exercise or for leisurely swimming, never set the swim spa water temperature above 80°F. Temperatures above 80°F can hinder the bodies ability to cool down and cause unnecessary cardiovascular stress.

 **WARNING:** People with infectious diseases or diarrhea should not use a spa or hot tub. **WARNING:** To avoid injury, exercise caution when entering or exiting the spa/swim spa. **WARNING:** Do not use the spa or swim spa immediately following strenuous exercise. **WARNING:** Prolonged immersion in a spa or hot tub may be injurious to your health. **CAUTION:** Maintain water chemistry in accordance with the manufacture's instructions. **WARNING: NO DIVING, diving may result in injury or death.** **WARNING:** The filter lid is a cosmetic item, do not sit or place heavy objects on the filter lid.

READ AND SAVE THESE INSTRUCTIONS

Preparing for Your New Portable Spa

Pre-Delivery Checklist

Most cities and counties require permits for exterior construction and electrical circuits. In addition some communities have codes requiring residential barriers such as a fencing and/or self closing gates on property to prevent children unsupervised access to the property by children. Your dealer can provide information on which permits may be required and how to obtain them prior to the delivery of the spa.

Planning the Best Location

Safety First

Do not place your spa within 10 feet (3m) of overhead power lines.

Consider How You Will Use Your Spa

How do you intend to use your spa will help you determine where you should position it. For example will you use your spa for recreational be sure to leave plenty of room around it for activity. If you will use it for relaxation and therapy, you will probably want to create a specific mood around it.

Plan for Your Environment

If you live in a region where it snows in the winter or rains frequently, place your spa near a house entry. BY doing this, you will have a palace to change clothes and not be uncomfortable.

Consider Your Privacy

In a cold weather climate, bare trees won't provide much privacy. Think of your spa's surroundings during all seasons to determine your best privacy options. Consider the view of your neighbors as well when you plan the location of your spa.

Before Delivery

- Plan your delivery route
- Choose a suitable location for the spa
- Lay a 5-8 cm concrete slab
- Install dedicated electric supply

After Delivery

- Place spa on Slab
- Connect electrical components

Provide a View with Your Spa

Think about the direction you will be facing when sitting in your spa. Do you have a special landscaped area in your heart that you find enjoyable? Perhaps there is an area that catches a soothing breeze during the day or a lovely sunset in the evening.

Keep Your Spa Clean

Think about the direction you will be facing when sitting in your spa. Do you have a special landscaped area in your heart that you find enjoyable? Perhaps there is an area that catches a soothing breeze during the day or a lovely sunset in the evening.

Consider How You Will Use Your Spa

Make sure the spa is positioned so that access to the equipment compartment (front panel) and all side panels are not blocked.

Many people choose to install a decorative structure around their spa with any type of gazebo, remember to allow access to service. It is always best to design special installations so that the spa can still be moved, or lifted off the ground

Note: We strongly recommend that a qualified, licensed contractor prepare the foundation for your spa. Damage caused by inadequate or improper foundation support is not covered in your warranty. It is the responsibility of the spa owner to provide a proper foundation for the spa.

Your spa needs a solid and level foundation. The area that it sits on must be able to support the weight of the spa, with water and occupants who use it. If the foundation is inadequate, it may shift or settle after the spa is in place, causing stress that could damage the spa shell and finish. Place the spa on a elevated 3 to 4"/30 cm concrete slab. Pavers, gravel, brick, sand, timbers, or dirt foundations are not adequate to support the spa, if you are installing the spa indoors, pay close attention to the flooring beneath it. Choose flooring that will not be damaged or stained by treated water. if you are installing your spa on an elevated wood deck or other structure, it is highly recommended that you consult a structural engineer or contractor to ensure the structure will support the weight of 150lbs per square foot (732 Kg/m²)



240 Volt Electrical Installation

Note: These instructions describe the only acceptable electrical wiring procedure. Spas wired in any other way will void your warranty and may result in serious injury. The electrical circuit must be installed by an electrical contractor and approved by a local building or electrical inspector. Failure to comply with state and local codes may result in a fire or personal injury, and will be the sole responsibility of the spa owner.

All 240V spas must be permanently connected (Hard Wired) to the power supply. When installed in the united states, the electrical wiring of the spa must meet the requirements of the NEC 70 and any applicable local, state, and federal codes. The power supplied to the spa must be on a dedicated GFCI protected circuit as required by the NEC 70 with no other appliances to lights sharing the power. Use copper wire with THHN insulation. DO NOT USE ALUMINUM WIRE. Copper wire must be used for your GFCI circuit, wires that run over 100 feet must increase the wire gauge to the next lower number. For example: a normal 50 amp GFCI with four #6 AWG Wire must increase wire gauge size to the next lower number, in this example #6 AWG to #4 AWG if the circuit is longer than 100 feet, would require four #4 AWG copper wires.

Removing Shipping Materials



Your Cal Spa is wrapped with a white shrink wrap designed to protect the acrylic shell from scratches and damage. Thoroughly inspect the plastic wrapping for any tears and or damage that may have occurred during shipping. It is expected to see some scuffs or small tears at the base and corners of the spa, as the spa is pushed and shifted around in transport.

Use a stainless steel cleaner or a damp microfiber towel to remove any residue or dust from the plastic wrapping if your spa is equipped with corners that have a stainless steel finish. Never spray directly onto the stainless steel trim or decor, spray onto a microfiber towel and wipe clean.

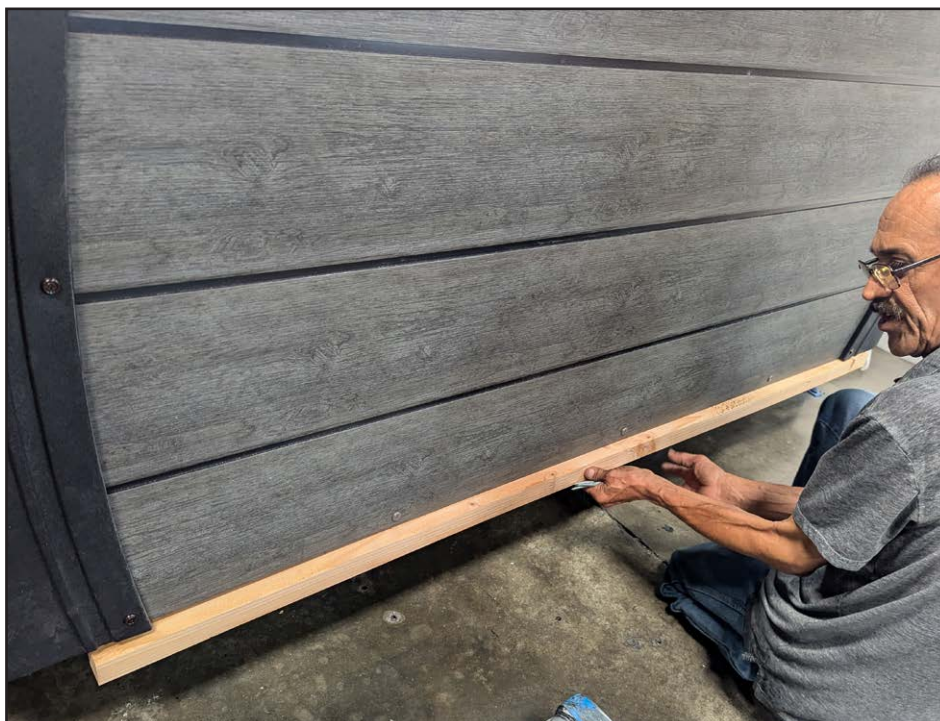

Depending on the type of spa, a piece of wood is placed on the side panels of the spa to protect it in shipping. The wooden supports are installed with several $\frac{7}{16}$ " (11mm) bolts, once the spa is in its final resting place, remove these with an 11mm socket.

Clearance for Service Access

While you are planning where to locate your spa, you need to determine how much access you will need for service.

All spa models require a minimum of three feet (one meter), of access to all sides of the spa for potential service. For this reason, the spa should never be placed in a manner where any side is permanently blocked. Examples include placing the spa against a building, structural posts, columns, walls, fences, or raised embankments.

If the spa is surrounded by a deck, ensure that there is easy access for service or repair. Decks should have the ability to be accessed or removed easily, some decks are built in segments for easy removal.

Spas require access in all sides in case they need service or repair. Additional service costs can be applied by the servicing dealer if a crane or additional manpower and equipment is needed to access the internals of the spa.

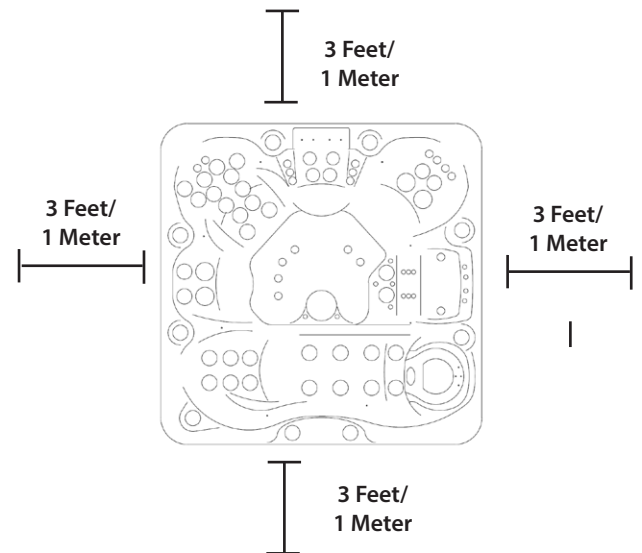

Opening the Front Panel For Electrical Access

Cal Spas are designed with innovative snap in panels and corners. In order to access the control box for electrical hook up, plumbing, or pumps inside of your spa, you will need to remove the corner panels and the front panel. The following tutorial is designed to illustrate the process of removing/re-installing any corner panel, and any side panel.



Caution: Pinch Points.

When snapping panels back into place your spa, be cautious of your hand position. Avoid placing your fingers or hands over the edges of corners or panels, it may result in injury once panels lock into place.

Before starting, make sure you wear gloves when removing any panel from your spa.



Step 1

In order to remove the front panel, the front corners of the spa must be removed prior to removing the front panel.

Note: Spa corners use support screws as well. Remove the screws from the corners. Do not pull on corners held down by any screw.



Step 2

Once the corner is removed, place aside with great care of not bending or stepping on the corner.

Repeat the removal process with the remaining corner(s) based on your service access needs.

Step 3

Once both corners are removed, place one hand under the front panel and one hand on either corner.

Once prepared, pull both the center and your chosen corner at the same time to release the panel.

Caution: Brace for the weight of the panel once it is removed. Failure to do so can result in injury such as pinched fingers, cuts, or other injuries.

**Step 4**

Once the panel is removed, use the wooden support boards to move your panel around if needed.

Note: Do not move your spa panel using the white clamp in mechanism.



Step 5

Once the front panel has been removed, your electrician or contractor may perform the necessary electrical work to power the spa.

Once the required work is completed, retrieve the panel and align the cabinet mounted plastic clamp with the bottom spa mounted plastic retainer.

Note: In order for the panel to align, the plastic clips must be leveled with each other. If the panel is misaligned, remove and reinstall the panel.

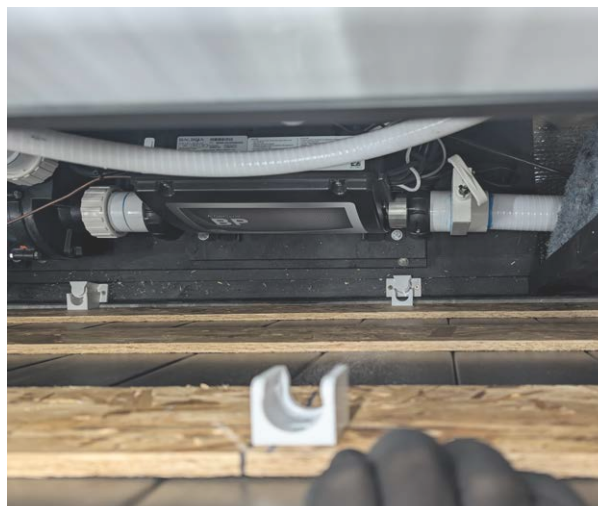

Step 6

Once the panel is aligned, apply medium pressure to the bottom center of the panel to secure it into place. Similarly apply pressure to the top center of the panel as well. You may also use the bottom of your fist to tap the panel back into place.

Note: The panels are secured once you hear and feel a *thump* securing the plastic clamp together with the base.



Step 7

Upon securing the front panel, proceed with installing the corners.

Similarly to how the corners were removed, align the corner with the lip of the spa, and ensure the top of the corner is under the black weather stripping of the spa shell. Reinstall the removed screws to secure the corner in place.



GFCI Wiring Requirements for USA & Canada

Control System	GFCI Required	Wires Required
IN.YE5 (1-3 pumps)	50 Amp	Four #6 AWG Copper Wires

GFCI Wiring Diagram for USA & Canada

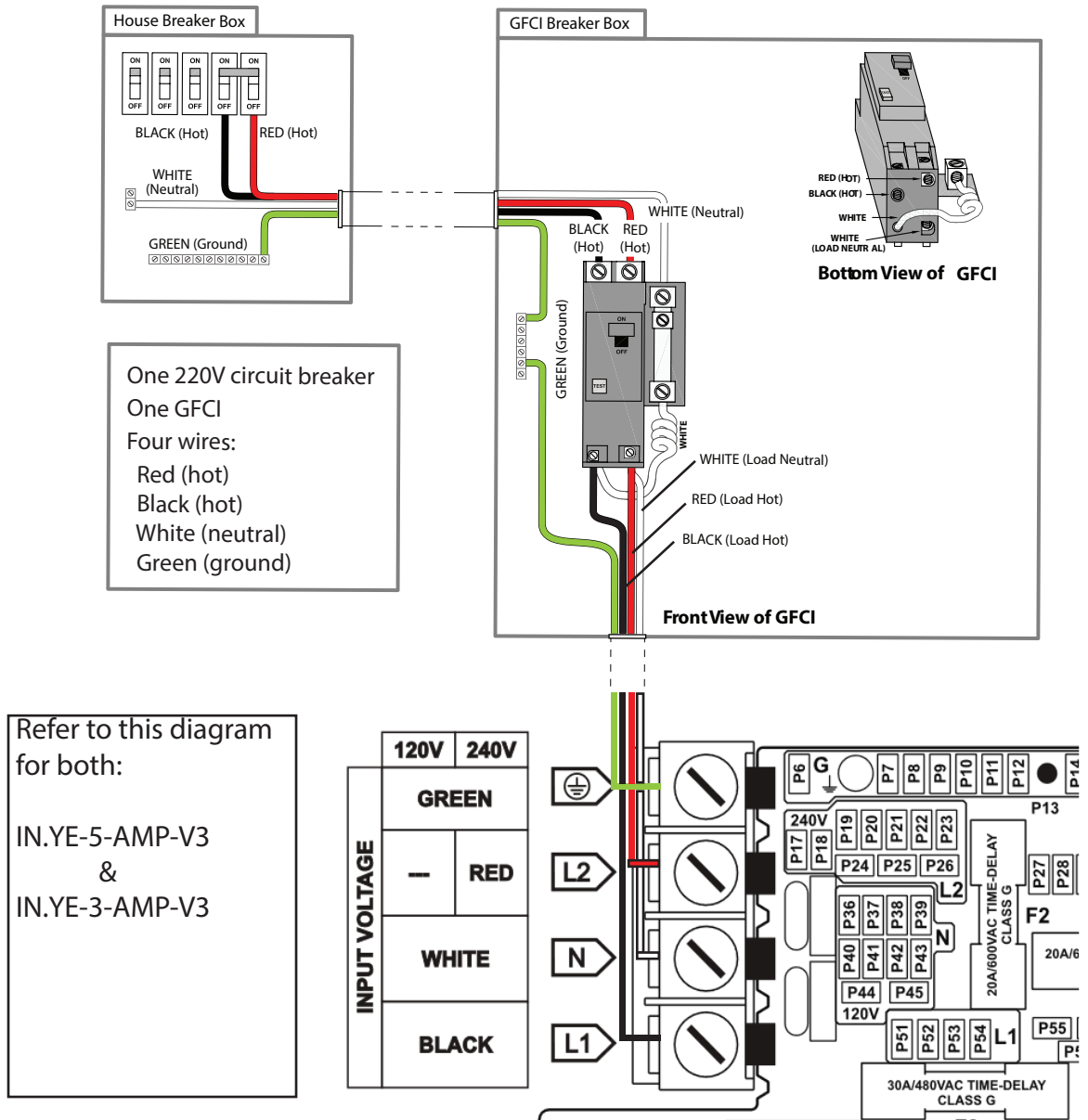

GFCI Breaker Testing

Before entering the spa for the first time or after each drain and refill, the spa owner must test the GFCI breaker. The GFCI

Filling and Powering Up the Spa

Step 1. Inspect the Spa Equipment.

Inspect all plumbing connections in the equipment area of your spa.

- Make sure unions connected to the equipment pack are tight (do not over-tighten)
- If your spa has gate valves, make sure they are in the upright position.
- Make sure the drain valve is closed and capped.

This image is for illustration purposes only. The spa Control box may appear differently than the illustration within your spa.

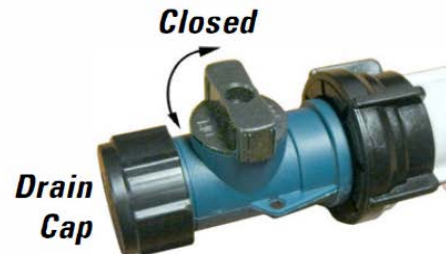
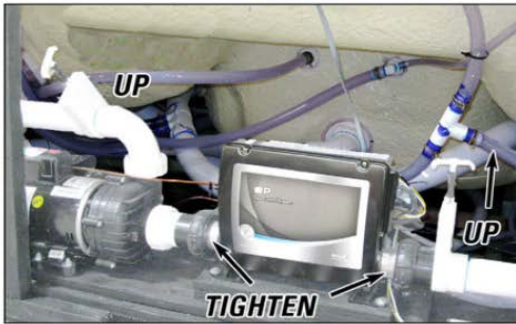

Note: Never run the spa with the gate valve closed or without circulating water for long periods of time.

Step 2. Remove the Filter Cartridge.

If you have a skimmer like this:



Teleweir filter skimmer

- 50 square feet filtration
- Spoked cap

Rotate and remove the locking ring (Color may vary). Remove the skimmer cap and barrel, grip the filter by the handle and unscrew it from the canister. Replace and lock the locking ring and slid the skimmer cap and barrel back into the canister. Once the spa is filled you can remove the skimmer cap and barrel again to reinstall the filter.



The skimmer and barrel are locked in place during shipping with a retainer ring. The retainer ring must be unlocked and removed in order to slide the skimmer upward to remove the filter cartridge.



When removing the filter cartridge, you may remove the filter by turning it counter clockwise. The filter must be removed gently to not damage the threaded fitting inside of the filter canister.



After removing the filter, reinstall the retainer ring to the canister, then reinstall the skimmer, this skimmer must be able to move up and down with your water level. In the following step you will fill your spa with water through the filter canister.

If the spa is equipped with a standard 50 sqft filter (black or gray), the skimmer is held in place with a locking ring during shipping. When preparing to fill your spa remember to remove the locking ring and remove the bobbing skimmer. Remove the filter by gently twisting the canister counter clockwise



Equipped on Deck Spas

Teleweir filter skimmer

- 50 square feet filtration
- Spoked cap

For Skimmers Like This

Rotate and remove the locking ring (Color may vary). Remove the skimmer cap and barrel, grip the filter by the handle and unscrew it from the canister. Replace and lock the locking ring and slid the skimmer cap and barrel back into the canister. Once the spa is filled you can remove the skimmer cap and barrel again to reinstall the filter. In the procedure down below a gray ring is used to better illustrate the locking rings position on the filter canister lip.



The skimmer and barrel are locked in place during shipping with a retainer ring. The retainer ring must be unlocked and removed in order to slide the skimmer upward to remove the filter cartridge.



When removing the filter cartridge, you may remove the filter by turning it counter clockwise. The filter must be removed gently to not damage the threaded fitting inside of the filter canister.



After removing the filter, reinstall the retainer ring to the canister, then reinstall the skimmer, this skimmer must be able to move up and down with your water level. In the following step you will fill your spa with water through the filter canister.



Note: The upcoming step on the following page explains how to fill the spa, though the spas filter canister. Salt system spas must use a prefilter to remove common TDS contaminants in municipal water.

Never use water from sources such as well water and water from water softener systems.

Step 3. Fill the Spa

Place the water hose inside the filter canister. Fill your spa with regular tap water about six inches from the top. If the water level is too low or too high, your spa will not operate correctly.

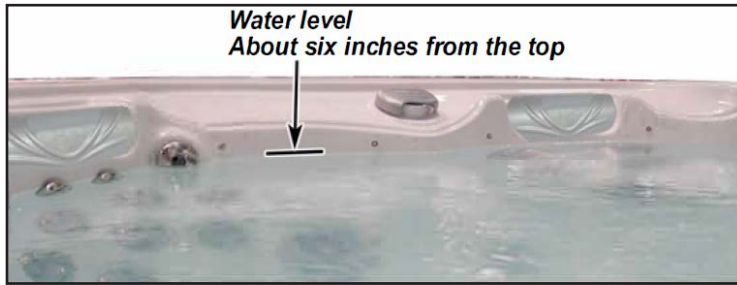

NOTE: Never fill with soft water.

Soft water made through some home filtration systems make it impossible to maintain proper water chemistry, and may cause water foaming. This can damage the finish of the spa and void your warranty.

You may fill your spa with well water, but only if the following preconditions are followed.

1. Purchase and use a pre-filter that can attach to the end of a hose. This pre-filter is absolutely necessary in order to remove reactive metals and other dissolved solids that are found in well water.
2. Perform a Total Dissolved Solids (TDS) and metals test, this can be performed by a qualified person after filling up the spa, before initial use. Most Dealers and pool supply stores can perform this test.
3. No salt system is installed onto the spa. If a salt system is installed in the spa well water and water from water softeners should never be used.

Step 4. Power Your Spa

When the spa is filled to the correct level, turn on the power at the GFCI breaker (ensure that the 120V spas are connected to their dedicated proper electrical outlet.)



Step 5. Prime the Main Pump

The system will enter priming mode when powered up for the first time. **Priming Mode** will scroll through the display on the control panel. In this mode all devices including pumps and lights are operable, you may press the jet buttons on and off to help prime the pumps. After a few minutes the system will exit priming mode.

Step 6. Install filter into the filter canister

Note: Make sure you have removed and soaked the spa filter cartridge in a bucket of water for at least 30 minutes. This will remove air pockets inside of the filter.

When re installing the filter cartridge, do not over tighten the filter, the threaded bit inside of the filter housing is made of a corrosion resistant ABS plastic. Excessive torque will break the internal threads within the filter housing.

**Step 7.** Test and Adjust Water Chemistry

Test and adjust the water chemistry.

Step 8. Let the Spa Heat Up

After a period of 5-15 minutes the priming mode will finish. The heater will then activate, put the spa cover on and let the spa heat to the desired set temperature.

During the initial power up the spa, it will consume a large amount of energy to raise the water in the tub to your desired hot tub temperature. Cal Spas are designed for high efficiency, once the temperature within the spa is reached, the spa will use lower amounts of energy to maintain the temperature.

Note: Cal Spas are designed to retain heat, if it is desired to lower the water temperature the spa does not contain a cooling feature. To lower internal temperature of the spa, lower the set temperature on the control panel and open the tub during the evening or night to help release the heat captured within. You may also drain 1/4 of the water within and refill with new water to lower temperatures rapidly.

New owners often have difficulty the first time they start their spa and the pumps fail to prime. This can be frustrating but these instructions should help you resolve any issues with air pockets inside of the primary pump or other priming issues.

Sometimes air can become trapped in the primary pump while filling up the spa, although this should be preventable by filling your spa through the filter basket, there is a chance that an air pocket can still form even when following the proper steps. Initially it may seem that the pump is not working, with some sound coming from the pump but no water movement.

Note: When a pump has an airlock, continuing to operate the pump experiencing an air pocket issue can damage the pump. Do not operate the pump until this airlock issue is fixed.

Start Up: Priming Mode

When the spa is powered up for the first time, the spa will enter priming mode. During this mode all devices within the spa is operational. You may wait for 10-15 minutes for the heater to engage, this period of time resets when a secondary pump is activated or if the primary pump is activated for high speed.

The spa will automatically exit priming mode.

Bleeding Air from the Pump

IF you have tried priming the pump by pressing the jet or jet 1 button on and off again with no results, you will need to bleed the pump manually.

1. Shut off power to the spa.
2. Using a philips head screwdriver, remove the front panel from the spa directly underneath the control panel, and locate the main pump.
3. Ensure that the gate valves are open
4. Place rags or towels under the plastic wet end of the pump where the spa plumbing connects into the pump
5. On the plastic wet end there will be a plastic hex headed bleeder valve that can be opened to bleed air trapped inside of the pump
6. Do not fully remove the nut, there are grooves within the nut that allows air to escape. Water will begin to trickle once the air pocket has been removed, tighten down the screw again with light torque.
7. If bleeding the pump is unsuccessful, loosen the pump unions with plumbing channel locks to remove any trapped air between the pump and the heater.
8. Turn the spa power back on and press the Jet button to prime the pump again.

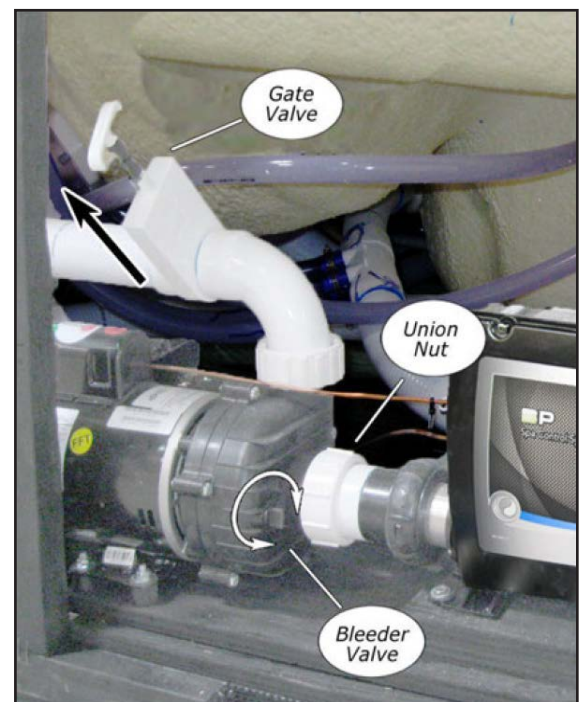

Keypad functions

in.k1000+ keypad layout

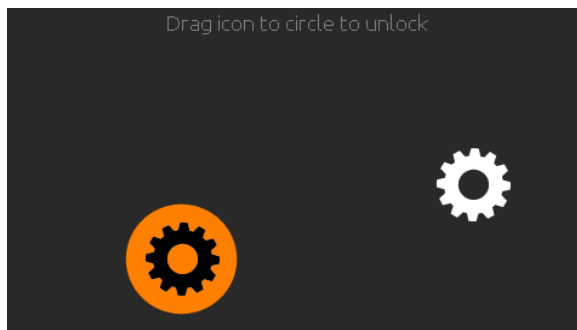

Sleep mode

Touch the screen to exit sleep mode. 3 minutes after the last pump is turned off, the screen will shut off if there is no touch activity.

Then Follow the instructions on the screen to access the main screen.

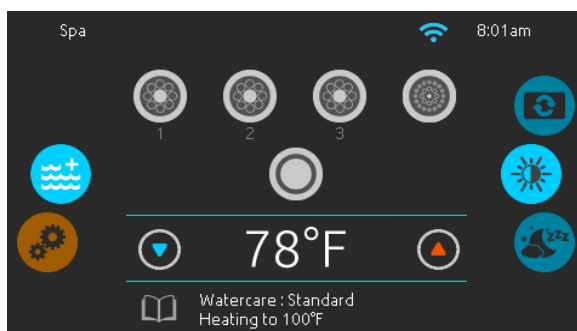

Main screen

The main screen gives you access to your accessories and water temperature. At the bottom of the screen you will see any error or maintenance messages that are present.

Keypad functions

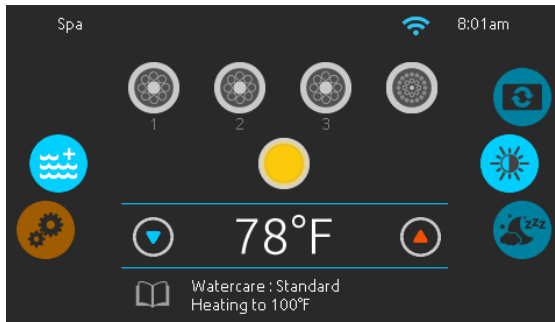

Start or stop accessories

To start or stop an accessory, touch the associated icon. Icons will become animated when their accessory is turned on and animation will stop when turned off. Icons on the screen will reflect the speed or state of the devices running on your spa. When an accessory has more than one speed press the button until it reaches the desired speed.

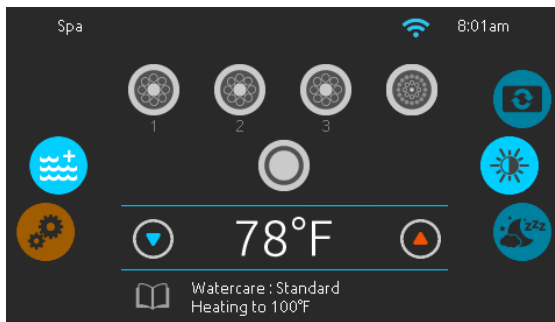

Notifications

A notification area at the top right-hand side of the screen shows the state of certain installed accessories.

Notification icons

- in.touch:**
- Indicates that the in.touch module is detected and connected to a Wi-Fi network.
 - A red cross indicates that the in.touch module is detected but is not connected to a Wi-Fi network.
 - An animated icon indicates that the in.touch module is connecting to a Wi-Fi network.

For more information about the in.touch, refer to the Wi-Fi section.



Want to avoid getting your owners manual wet? Or use a smartphone to quickly reference the control panels features and controls.

Scan this QR code to access a digital version of your control panels operators manual.

Keypad functions

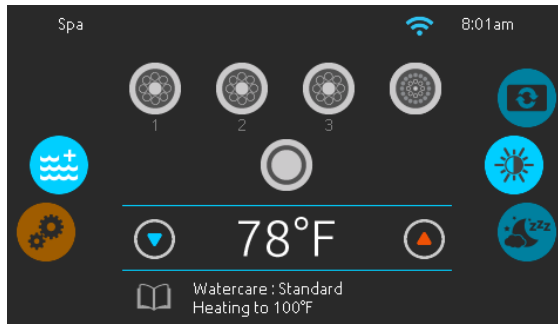

Water temperature

The temperature shown at the bottom of the screen indicates the current water temperature. Use the Up and Down icons to set the desired temperature. The set point will appear in blue. After 3 seconds without any change to the set temperature value the current water temperature will reappear in white.

When the set value is lower than the current temperature *Cooling to xx.x* will appear below. When the set value is higher than the current temperature, *Heating to xx.x* will be indicated under the value.

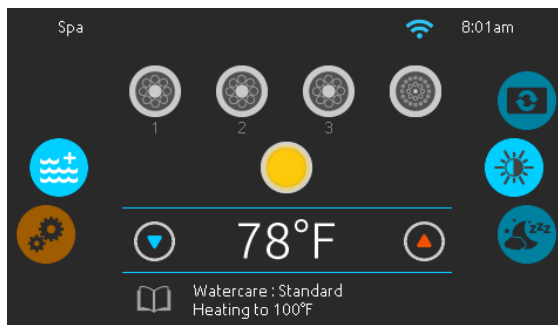

Spa menu

From the home page you can access the following:

- *swim* (if configured)
- *in.clear* (if installed)
- *in.stream 2* (if installed)
- *in.mix* (if installed)
- *Spa menu*
- *Settings*

To select an option, slide the left wheel up or down until the desired icon menu is highlighted in the middle.

On the right side is a menu for access to the Display and Contrast pages.

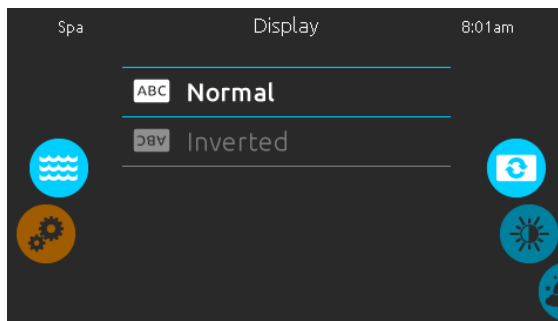

Display page

Use this page to change the display orientation.

Keypad functions

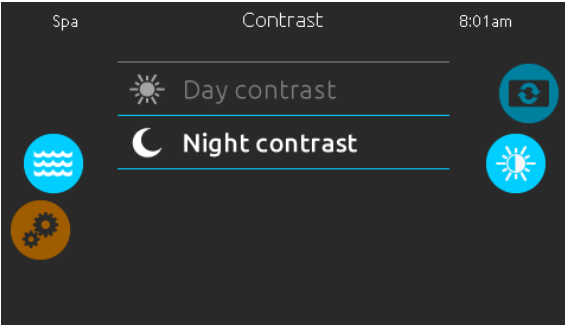

Contrast page

Use this page to change the display contrast.

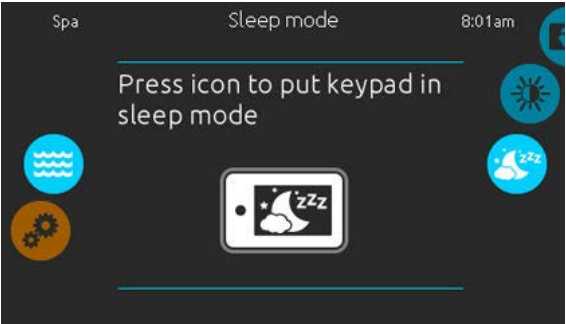

Sleep

Press key to go directly into the sleep mode. In sleep mode, water splashing on the keypad can't inadvertently start/stop a pump.

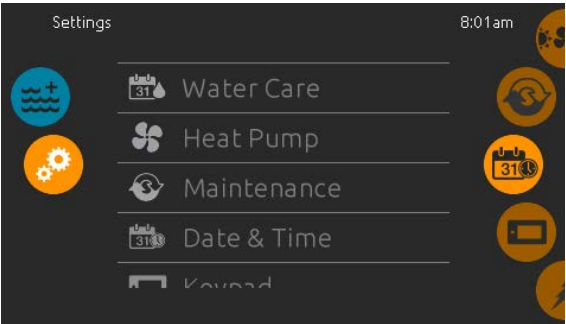

Settings

In the Settings page you can access the following:

- *Water Care*
- *Heat Pump (if installed)*
- *Maintenance*
- *Date & Time*
- *Keypad*
- *Electrical Config*
- *Wi-Fi*
- *Miscellaneous*
- *About*

To select an item, slide the right wheel until the desired icon is highlighted in the middle or press on the menu name.

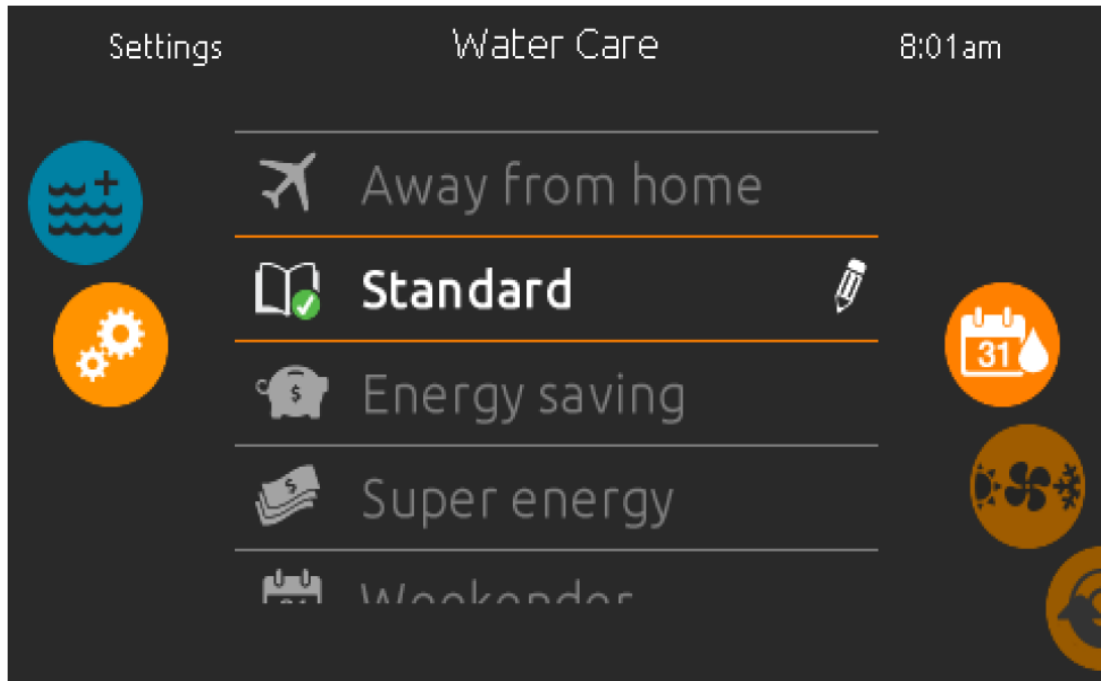

The water care page will help you set up your ideal filtration and heating settings. There are several preset modes that tell your heater when to activate. First you must select your preferred energy mode, *for almost all customers the “Standard” mode is ideal. On standard mode the heater will turn on when its necessary to maintain the temperature of the spa (+/1.5F°).*

Ideally if you as the spa owner are keeping costs in mind, and wish to customize the spas heating to specific days of the week when you expect to use it. In water care modes such as “Weekender” the system will only heat up on Saturday and Sunday when date and time in the control panel is set accurately.

Selecting a water care mode determines how the spa heats up. Not how it filters.

When you select a Water Care mode you will be able to make your own filter cycles under each mode for ultimate customization. The following page assumes that the spa is being operated in standard mode, and shows how to set filtration times and duration. Each water care mode has customizable filter cycles, and has the most Eco-Friendly filter cycle already preset from factory. *For spas with a 24hr circulation pump, it is critical to select your preferred Water Care energy mode and adjust the filtration duration to 24hrs.* The following page will go in depth on how to set your filter cycles, within a spa using standard mode.

Each water care mode has its own unique filtration cycles, the gecko ink.1000 control system allows you to customize each mode to your liking.

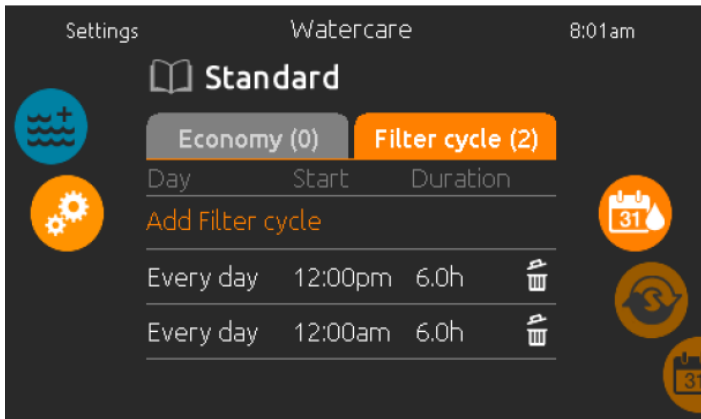

After selecting your preferred water care energy mode, you can select and configure the filtration modes within the mode you have selected. **For most cases we advise to set the spa to standard mode**, after it is selected you can press the pencil icon next to the selected energy mode, and edit filter cycles.

Within this menu you find two tabs one for filter cycles and one for economy. These tabs allow you to fine tune your spas behavior to your preference. **There is not real need to modify the Economy Tab unless leaving for vacation or you intend to leave the spa for a period of time without heat.**

Adjusting Filter Cycles

1. First you can press the trash icons near the pre-installed filter cycles, that way you can start with a clean slate. If the pre-installed filter cycles match up with your spa preferences, no further action is needed. A minimum of 4hrs total filtration a day is advised.
2. "Tap Add Filter Cycle" to add a custom filter cycle that you prefer. A new menu will appear showing you several option for filter cycles.
3. You can select the regularity of the filter cycles from options such as Mon-Fri, Weekend, Every day, or specific days of the week. For our spas we advise setting the filtration for "Every day".
4. Set the start time of the filter cycle and a minimum of 4hrs of filtration. You may add a secondary filter cycle if you wish to split the filtration times to different parts of the day.
5. For spas equipped with a 24hr circulation pump, set the time from 12am to 12am. This way the controller understands that you wish to initiate the 24hr filtration system.

Economy Settings

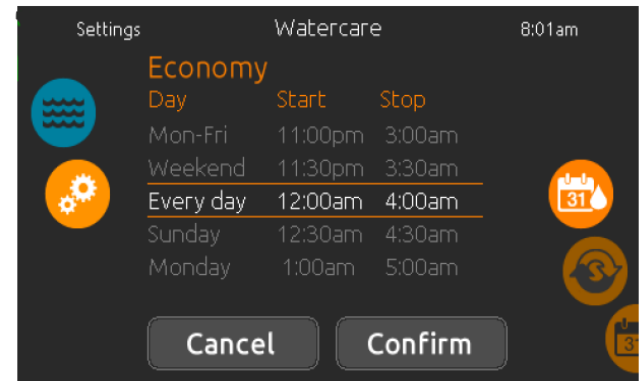

The secondary tab within this screen is the "Economy" tab. Inside the economy tab you are able to activate an Economy mode or modify a preset Economy mode that if designed for the selected water care mode you are in. **Economy mode tells the heater to avoid heating up the spa during a time frame unless the water temperature falls bellow 20F°** to avoid higher energy costs or reduce the electrical loads of the home.

The secondary tab within this screen is the "Economy" tab. Inside the economy tab you are able to activate an Economy mode or modify a preset Economy mode that if designed for the selected water care mode you are in. **Economy mode tells the heater to avoid heating up the spa during a time frame unless the water temperature falls bellow 20F°** to avoid higher energy costs or reduce the electrical loads of the home.

Adjusting Economy Mode

1. Select the Economy tab and a similar menu to the filter cycle menu appears.
2. Similar to the filter menu, you can select and command at what time and/or how long the heater remains in economy mode for.
3. If you do not wish to change the settings press cancel and the economy mode programing will cancel.

Keypad functions

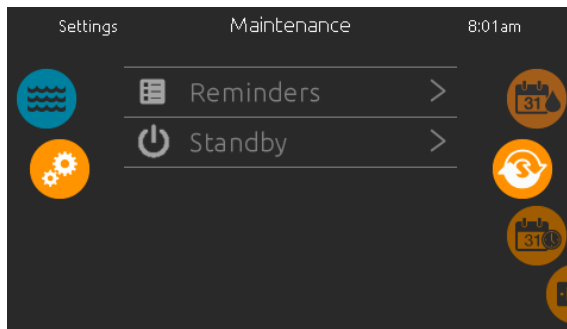

Maintenance

From the Maintenance page you can access the following:

- *Reminders*
- *Standby*

To access the desired option simply touch the corresponding menu item.

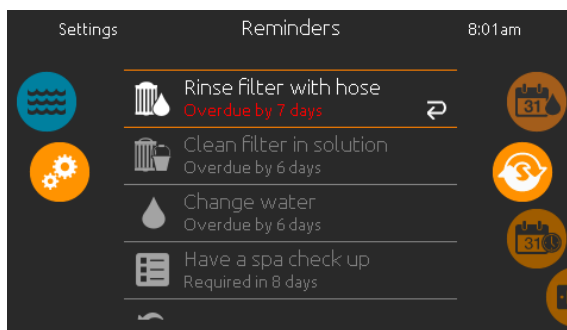

Reminders

The in.k1000+ keypad will provide reminders about maintenance required on your spa, like rinsing or cleaning the filter. Every task has its own duration based on normal use.

The Reminders menu allows you to check the time left before maintenance is required, as well as to reset the time once a task has been completed.

To reset a task, select it by pressing the curved arrow, then confirm when prompted. Once you have confirmed, the task will be reset.

You can also use the option *Reset Reminders* to reset all the reminders.

Energy Mode Presets

If you wish to use a preset mode within the gecko system, the following summary can help you decide what water care mode is best based on your spa usage.

Each of these modes are customizable allowing you to have full control of everything occurring within your spa.



Away from home:

In this mode the spa will always be in economy mode; the set point will be reduced by 20° F.



Super Energy Savings:

The spa will always be in economy mode during peak hours, every day of the week.



Standard:

The spa will never be in economy mode and will be filtering according to the pack's low level configuration.



Weekender:

The spa will be in economy mode from Monday to Friday, and will run normally on the weekend.



Energy Savings:

The spa will be in economy mode during the peak hours of the day and resume normal mode on the weekend.

Keypad functions



Set date

Here you can adjust the year, month and day.

Simply swipe up and down the column you want to change and select the desired value. When you are done, touch the calendar icon at the right of the screen.

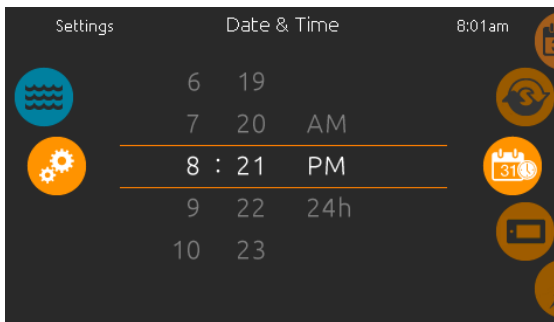

Set time

Here you can change the hour, minute and time format.

Simply swipe up and down the column you want to change and select the desired value. When done, touch the calendar icon at the right of the screen.

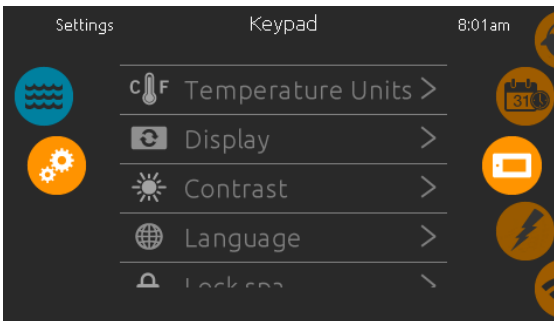

Keypad settings

In the keypads page you can access the following:

- *Temperature units*
- *Display*
- *Contrast*
- *Language*
- *Lock spa (optional)*
- *Keypad color (optional)*

To select an item, slide the right wheel until the desired icon is highlighted in the middle or press on the menu name.

Keypad functions

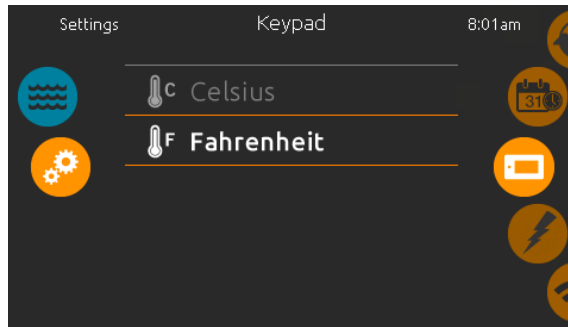

Temperature units

Choose the desired units to display temperatures.

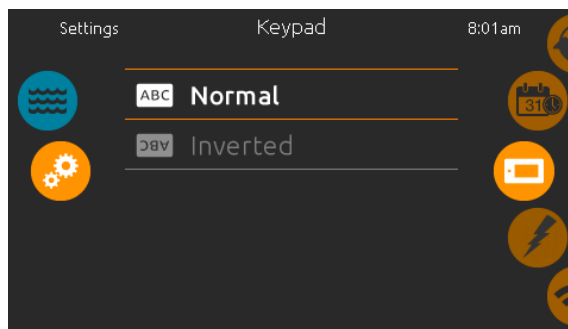

Display page

Use this page to change the display orientation.

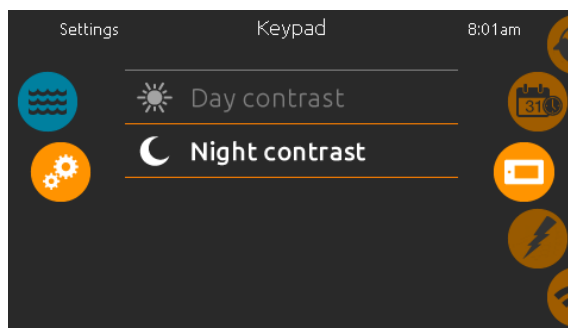

Contrast page

Use this page to change the keypad contrast.

Keypad functions

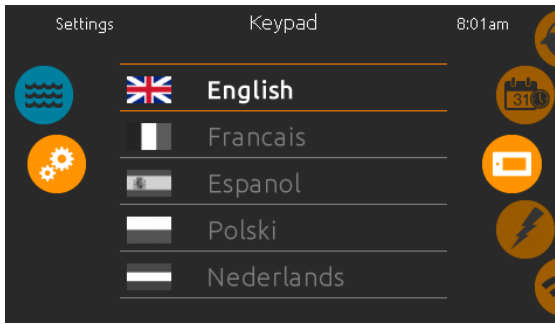

Language select

Use this page to select the display language of the in.k1000+ keypad.

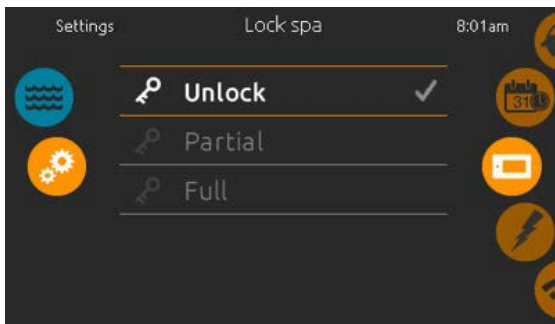

Keypad lock/unlock (optional)

When this option is enabled, the user can partially or completely lock the keypad. When the user wants to lock the keypad he is asked to select a 4-digit code. The same code will be needed to unlock the keypad. Next time he wants to lock the keypad, he will be prompted again to select a 4-digit code (same functionality as a Safe in a hotel room).

The keypad can be unlocked with a universal unlock code (3732) or by a reset of the keypad.

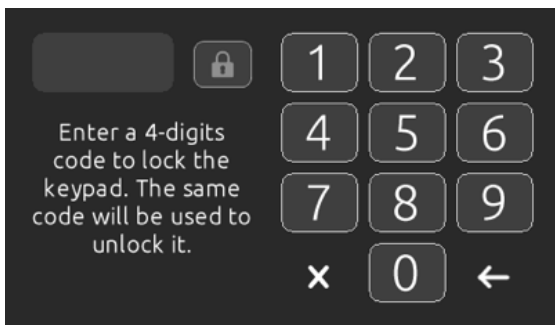

When Full Lock is selected, all functions are locked.

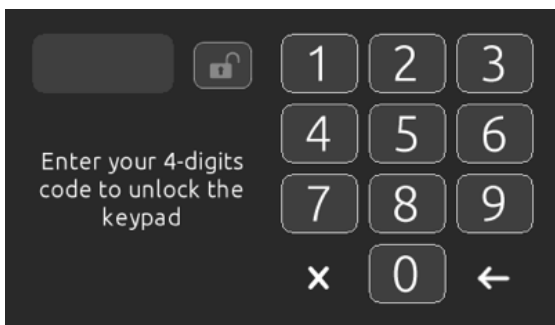

In Partial Lock, you may only activate accessories. Settings may not be changed in this mode.

"in.touch" Wifi Transmitter Set Up

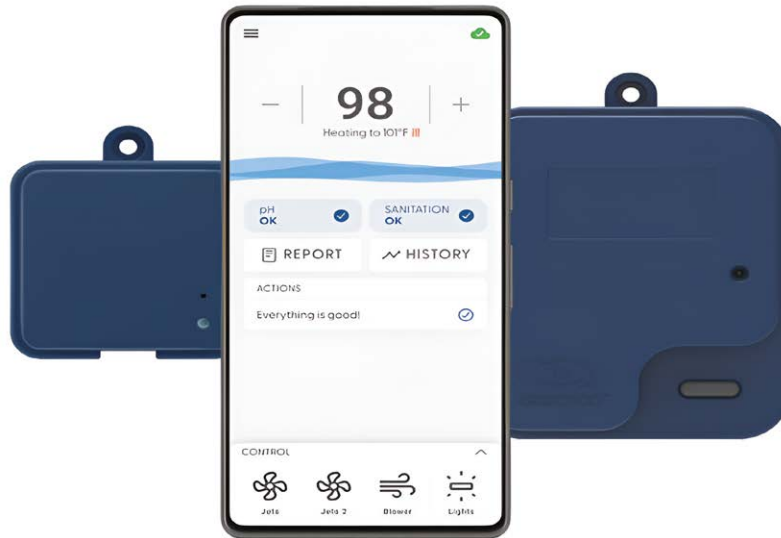

Congratulations for purchasing the optional on Wifi control system. This control system will allow you to observe the spa and control it's features such as temperature, filter cycles, energy saving modes and much more when you are away from home, out of state, or even out of the country.

Please Install the **"Smart Spa Control"** app developed by Gecko from the app store or google play store.



Apple App Store



Google Play Store

Installing the Home Transmitter:

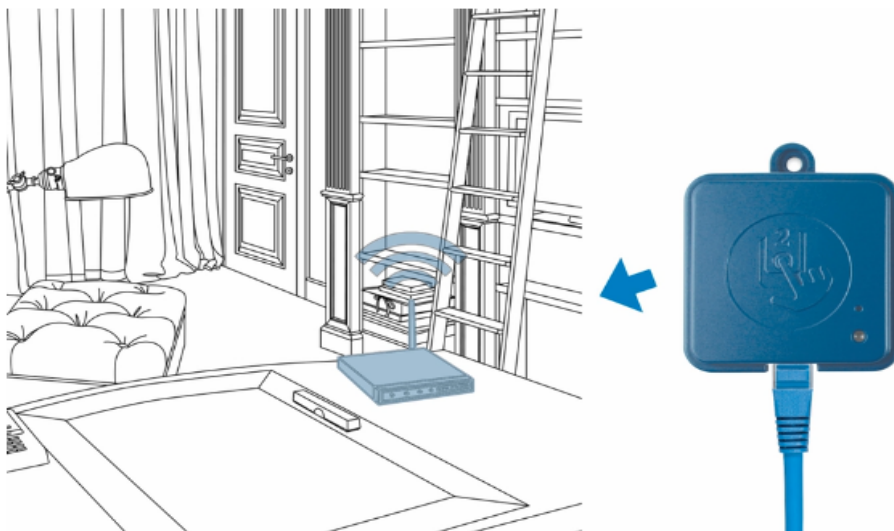

The home transmitter is provided with an ethernet cable and a power supply.

The in.touch home transmitter unit must be installed inside the house, connected to a router and powered by the provided wall transformer. A longer ethernet cable may be used to bring the home transmitter closer to the spa.

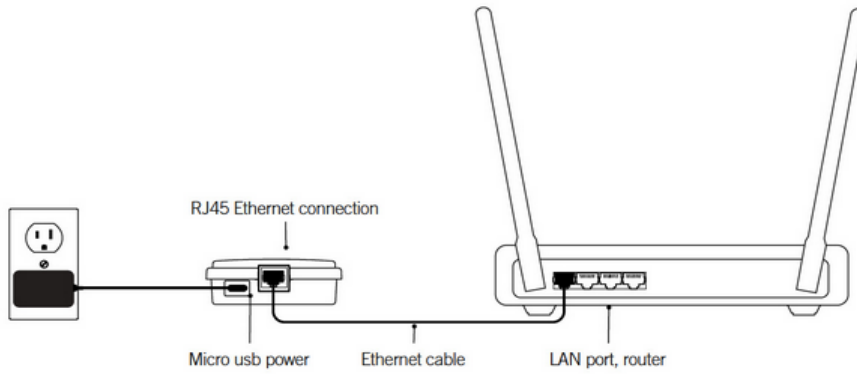

Simply connect the ethernet cable into the RJ45 port of the in.touch 2 home transmitter and in one of the available LAN ports on your router. To power up the home transmitter, plug the provided wall outlet charger to a 120V (North American model) or 220V (European model) household supply and connect the USB cable to the wall outlet and the home transmitter.

After the home transmitter is connected; connect the internal spa transmitter:



The Wifi module is installed when manufacturing of your spa if the add on was requested.

Contact your dealer to confirm if your spa is equipped with a Wifi module.

If you purchased a spa with in.touch as a standard feature or as an option, note that the spa transmitter will be pre-installed.

To ensure proper signal transmission, it may be necessary to change the position of the transmitter once the spa is installed in the yard. The transmitter should be located on the side of the spa facing the house.

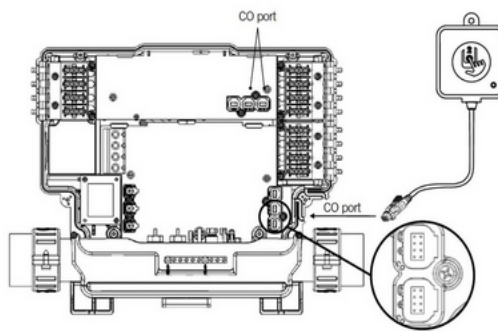

The in.touch spa transmitter must be installed under the spa skirt, at least 12" (30 cm) away from any metal component or structure, as close as possible to the house to optimize the signal strength.

Simply connect the spa transmitter into an available CO port of the spa control system

"in.touch" Quick Start App Guide

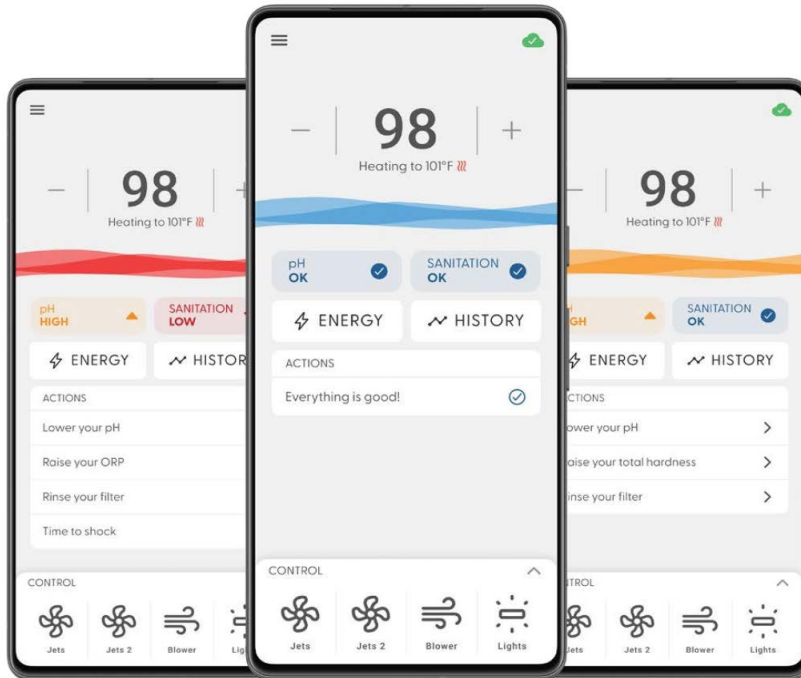

The Gecko "Smart Spa Control" app is an effective tool to monitor, adjust, or activate your spa. Once the two wifi modules have been connected, approach the spa and open the app.

Ensure that both your devices wifi detection and Bluetooth signal are on, and that your current device is charged to at least 50% before starting the pairing process.



Apple App Store



Google Play Store

Both Transmitters for your spa are paired from factory, providing electrical power and stable Internet connection are necessary for both in.touch wifi modules to communicate. A technician may need to adjust or reposition the spas wifi module to face towards the home transmitter.

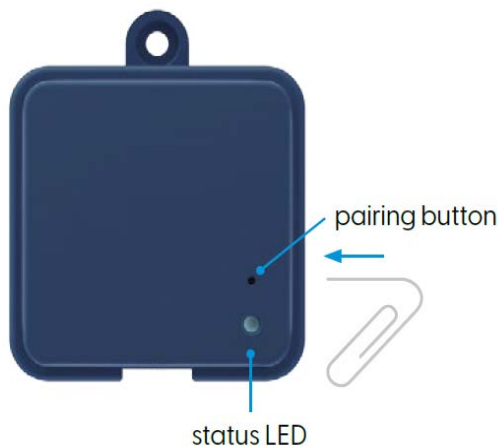

If connection issues persist, un-pairing and pairing the home transmitter may be necessary. Using a paperclip you may insert the end of the clip into the pairing button. The status LED should begin flashing yellow in a rapid pattern to show it is now in pairing mode. It will remain like this until the home module is paired or if the power is cut off to the home module.

Once the home module is flashing yellow, proceed to the spa and turn the power to the spa off at the breaker. Keep the spa turned off for at least 5-10 seconds, then turn the spa power back on. The modules will begin searching for each other and a pair once again.

If issues persist, contact your spa dealer to schedule a service technician, in order to determine the issue or to process a warranty claim.

"in.touch" Quick Start App Guide



Download the "Gecko Smart spa control" app from the App Store or the Google Play store to proceed with wifi control set up.

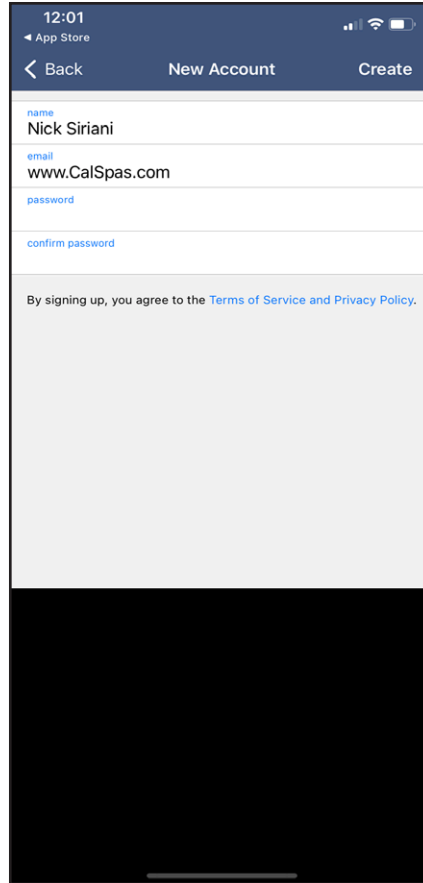

Once the app is downloaded, select "Create an Account" and fill in the requested information to create your account.

Ensure that your Home Wifi module is powered on and connected

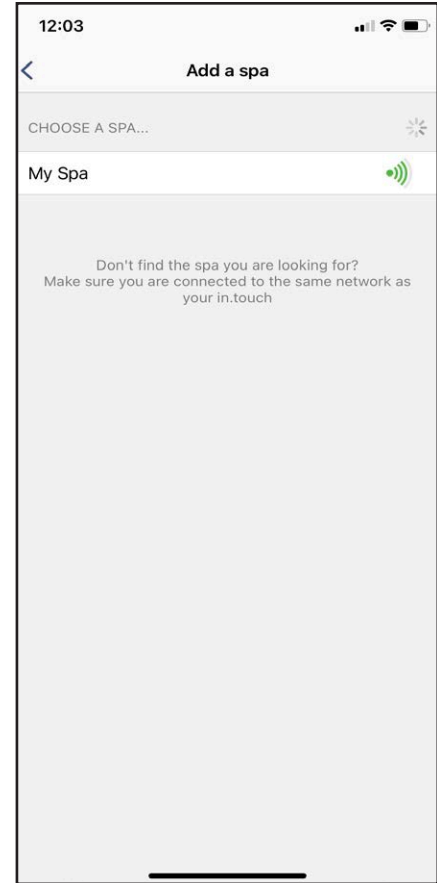

Once the account is confirmed via email, return to the app and the app will begin to search for new spa devices, the spa wifi module will appear.

Select the spa module, the module is now paired.

Congratulations, your in.touch Wifi controller is now paired and ready to use. This app can be used when you are not near your spa to monitor and control the spas activities.

Keypad functions

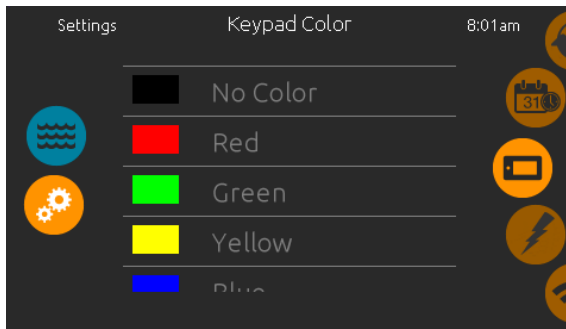

Keypad Color (optional)

If this option is available (depending on the spa configuration), the keypad rim color can be changed. 8 pre-defined colors are available. If the in.mix is installed, the keypad rim color can also be associated to an in.mix zone.

! Electrical Configuration for Certified Spa Technicians Only !

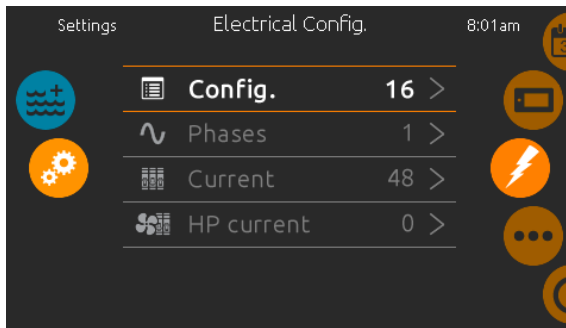

Electrical Configuration

Please do not make any changes in this section unless you are a qualified electrician.

In this section, you can change the low-level configuration, modify the number of phases, change the input current value as well as change the Heat Pump current. Once the modification is done, hold the Apply button for five seconds.

All Cal Spa units are pre-configured during manufacturing.

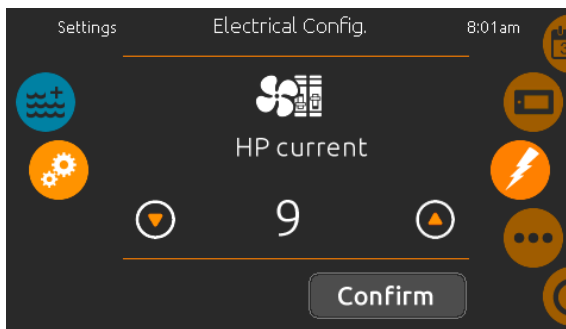

If you are a technician installing a new spa pack, please contact technical support.

1-800-629-3890 (ext 777)

* Depending on the pack configuration, a code may be required to modify these settings. This code is 5555.

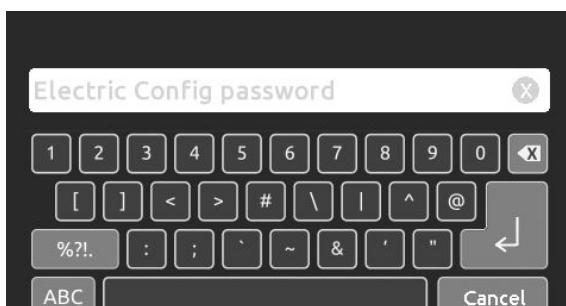
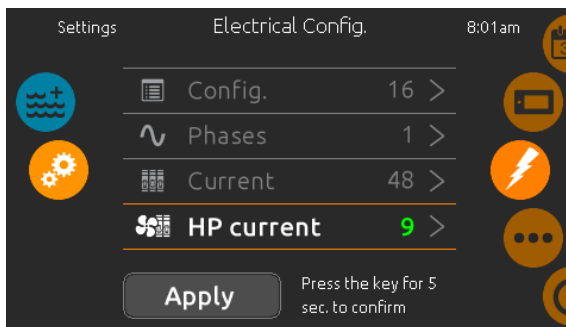

Keypad functions

Thermal Creep: During the hotter months of the year or when ambient temperatures rise above 85F°. The heat generated by the spa equipment will begin to warm the spa water without the heater engaging, this is called Thermal creep. This occurs due to the high efficiency insulation of the spa retaining heat. Longer filter cycles will raise temperatures when ambient air temp reaches this threshold. The use of Warm Weather mode will help turn off your filtration cycles once water temp rises.

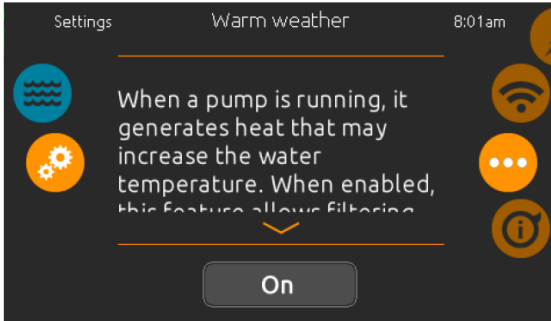

Warm weather

When pumps are running, they produce heat that may increase your water temperature. "Warm Weather" option gives you the option to bypass the pack filtration over-temperature feature. When Warm Weather is "OFF" the filtration over-temperature is disabled and your spa filtering will continue even if the water temperature is high.

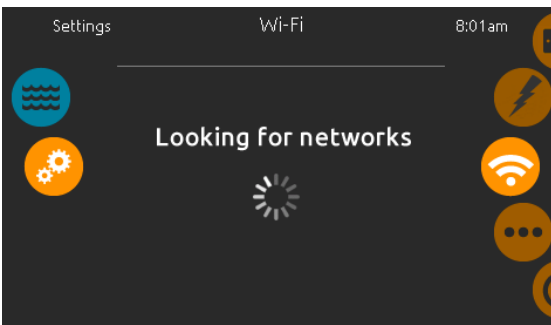

Wi-Fi (in.touch only)

This page allows you to connect your in.touch module to a Wi-Fi network or to change its network.

For more details about other in.touch connection methods, please see the in.touch techbook.

After a few seconds the available networks will appear on the screen, as well as their signal strength.

Swipe Up or Down the list to select your network. If the Wi-Fi network is password protected, enter it when prompted.



If no password is required, the in.touch will connect automatically.

Once the in.touch module is connected to a Wi-Fi network, a green check mark will appear in the Wi-Fi menu and the network name will appear in the *Settings* menu.

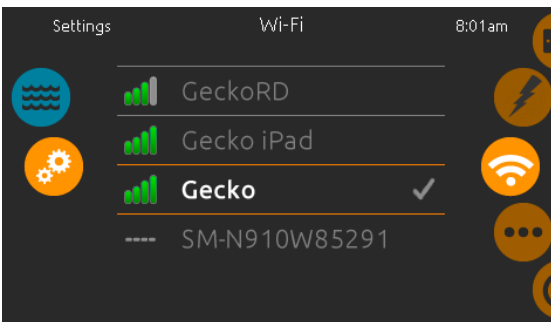

Error messages

The list below shows the different error messages that can appear on the home screen.

Refer to the troubleshooting and error codes section of the TechBook for your spa pack system.

Please note that if you are in a swim spa configuration, the message may be followed by "Master" or "Slave" to designate from which pack the error is coming.

Code	Message
HL	High Limit circuit has tripped!
FLO - L01 FLO - L02 FLO	FLO condition - Check filter, pump, blockage, air lock and water level
NO FLO	Persistent NO FLO, all off - Check filter, pump, blockage, air lock and water level
HR	A hardware error was detected (Relay stuck)
OH	Spa temperature is too high
Pr	Temp probes or detection circuit are defective
AOH	Elevated internal temperature
FLC	The pressure switch is closed
SP in	Input voltage issue
RH NC	Comm. error between in.xm2 - in.therm
RH ID	in.xm2 and in.therm incompatible
SC ER	Error detected during the learning mode
F1	in.xm2 Fuse # 1 is blown
F2	in.xm2 Fuse # 2 is blown
F3	in.xm2 Fuse # 3 is blown
ER1	SwimSpa config. : slave unit is missing
Hr	Hardware error was detected (Thermal fuse)
UPL	The spa pack does not have valid software. Please insert valid in.stick to reprogram spa pack.
CFLO	No Flow condition
HIBr	Add fresh water to the spa
HiBr	Add fresh water to the spa

Electrical Power Efficiency Tips

Your new spa comes equipped with a premium 5.5kWh titanium electric heater. Follow the directions listed below, it will help ensure the most efficient spa operation. Some models have the option to combine your spa with a Gecko “in-Temp” heat pump, this information is still relevant to spa owners with either the 5.5 kWh heater or the add on heat pump .

Note: This method is only for spa usage under two hours a week.

- Keep the spa operating temperature about 5F below your usual preferred temperature when not in use. Raise the temperature to your preferred temp about one or two hours before you enter the spa to save on energy costs if your usage is within the range of two hours per week.
- If you use your spa more than two hours a week total, keep the set temperature at your desired temperature.
- The air venturis should be used sparingly when open, water temperature drops depending on ambient temperature as this air is now being injected into the water.

Allowing the water temperature to lower more than 10F below the desired usage temperature, and re-heating it prior to usage, will cause the heater to operate longer than keeping the spa about 5F below. This will increase your operating costs. We recommend getting your spa up to your desired temperature, and then lowering the set temperature by 5F once its reaches the desired temperature. Our spas are designed to retain as much heat as possible to ensure your save on long term costs.

***Note: The most electrical power is consumed in the initial fill up, as the tap water needs to be brought up to hot tub temperatures.**

Jets

Almost all of the jets in your spa are adjustable. Rotating the jet face clockwise will increase water pressure, and counter clockwise to reduce pressure on that specific jet. Neck jets are the opposite, with clockwise movement to decrease force, counter clockwise to increase.



LED Lighting

Press the “Light” button on the topside controller to turn the spa light on. If your spa has optional perimeter LED lights, they will also activate.

1. **Cycle:** When you press the “Light” button on and off repeatedly the LED will cycle between a variety of colors that the RGB light can support.
 - *Each time you press the button it will immediately advance to the next color in sequence and will eventually enter different light pattern modes.*
2. **Flashing:** Once you have cycled through all of the colors, another press of the “Light” button will produce a flashing pattern.
 - Every air valve is equipped with 2 LED points.
 - The waterfall takes 4 points of light. Spas with exterior LEDs work in the same mode as described above. The variations in color and patterns provide you multiple customization options.
3. **Fading cycle:** The next phase of operation when you push the LIGHT button is a slower and/or fast fade random transition from one color to the next.
 - If a spa is equipped with more than 100 points of light the slow fading cycle will flicker during a color change.

LED Under Glow

Certain Cal Spa models are offered with the add on option of our new LED under glow lighting system. This lighting system works alongside the interior spa lighting, whenever the spas main light is activated the under glow will also activate. The color/pattern projecting from the perimeter under glow, will match the color/pattern within the spas interior LEDs.



Diverter Knobs

Diverter knobs are 1" and 2" knobs located around the top of your spa. They allow you to divert water through jets from one side of the spa to the other, or in most cases from floor jets to all jets. This is accomplished by rotating the diverter knob to the left (counter-clockwise), decreasing the amount of water flow through a section of jets. To increase the amount of water flow through the other section of jets, rotate the handle to the right (clockwise)



Air Venturis

Air venturis are the 1" knobs located around the top of your spa. Each one will let you add a mixture of air with the jet pressure. This is accomplished by rotating the air venturi knob to the left (counter clockwise) to increase the amount of air flow. To decrease the amount of airflow through the jets, rotate the handle to the right (clockwise)



Waterfall (option)



Note: Images are for illustration purposes only.

Some Cal Spas are equipped with a waterfall feature, with LED lights inside the housing. The flow of the waterfalls water can be adjusted in most spa models by turning a designated water diverter inside of your spa.

ATS Therapy Seat System

Pump Button (On/Off):

Press the "Pump" button to activate the ATS system. The pump will turn on full speed with letter "H" displayed in the LCD panel, the pump LED light will turn on. Press the pump button a second time to turn off the ATS system. In order to use the pulse features within the ATS system you must press "Pump" button before pressing "Pulse".

Pulse Mode Button:

Once the main pump is activated and is running on H mode, press the "Pulse" button. The previously selected pulse mode number will appear on the LCD screen. There are a total of 9 pulse modes, this can be changed using the "Up" and "Down" buttons. You may press the "Pulse" button again to exit pulse mode and enter high speed "H" mode.

Up/Down Buttons:

These Buttons only function when the ATS system is in pulse mode. When toggling the "Up" and "Down" arrows cycle through 9 modes and a demo mode "d". In demo mode the seat will cycle through all 9 modes for 30 seconds on each number. You can exit demo mode by pressing the "Up" & "Down" arrows or allow demo mode to complete all 9 thirty second cycles.

Time Out:

The pump has an automatic shut off after 15 minutes of continuous operation. When using any selected pulse mode the mode will last for only 15 minutes. If you plan to use the ATS system for an extended period of time the follow section will explain how to use the system without engaging the overheat protection of the ATS pump.

Pump Protection:

When the pump is set for any pulse mode, the pump will surge in temperature. The pump is designed with an overheat protection to ensure longevity of the system. To avoid the thermal cut out from activating you may select a pulse mode, after the first mode ends press the "Pump" button for high speed for at least 5 minutes. When the pump will rapidly cool when set to high speed mode. After 5 minutes of use you can once again press the "Pulse" button and select your next massage mode.

Note: Always activate the high speed pump between therapy numbers to prevent the pump from over heating.

Pump Purge:









To prevent water stagnation within the ATS plumbing, The ATS pump will kick on once a day to purge. This occurs every 24 hours and will run for 20 seconds, showing a "P" on the display.

ATS Temp Sensor:

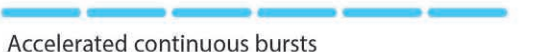
The ATS sensor is used to monitor temperature to prevent the ATS system from freezing or overheating. If the temperature is too cold the pump will kick on full speed and show "F" on the display to prevent freeze damage. If the system is too hot, all pump operations on the ATS seat deactivates and the letter "C" will appear on the display. Depending on temperature the pump may activate in high speed mode to cool the pump down, the thermal cut out may activate, and will stop all pump operations for 30 minutes.

If there is a sensor issue a flashing letter "E" will display on the controller. The ATS system will operate for one cycle but after the 15 minute cycle ends a flashing "L" will display on the controller. Contact your dealer for service to replace or fix the sensor within the ATS system.



- 1  Low rolling bursts
- 2  Medium continuous bursts
- 3  Accelerated continuous bursts
- 4  Swift rolling bursts
- 5  3 gentle bursts followed by 1 vigorous burst
- 6  Quick, powerful continuous bursts
- 7  Gentle, powerful alternating bursts
- 8  Medium low rolling bursts
- 9  Extended low rolling bursts

Throttle Seat Variable Speed System (option)

Massage Pump

Some spas have the option to install a variable speed pump with its very own control panel, that can be used in a massage therapy seat. This pump has the ability to pulse and activate on an interval to massage the body of the user sitting in a spa seat connected to this variable speed pump. This pump operates independent to the main control system inside of the spa. A dedicated control panel is included in order to operate the variable speed pump.

The Flx-Go control panel is a fully independent control system within your spa.

Note: If your spa is equipped with a Throttle Variable Speed Pump, selecting options such as setting the temperature and filter cycles within this control panel, will not affect actual spa operation.

Keypad layout



Power

Rotate the dial ring of the flx.go to turn on the keypad. After 2 minutes of inactivity, the keypad will revert to the sleep mode screen and after 4 minutes of inactivity, the screen will shut off.



Note: Before using the seat for the first time, make sure that the temperature is set for 60F. This is important for the control system to not run the Throttle Seat pump without activating a massage mode.

Navigation

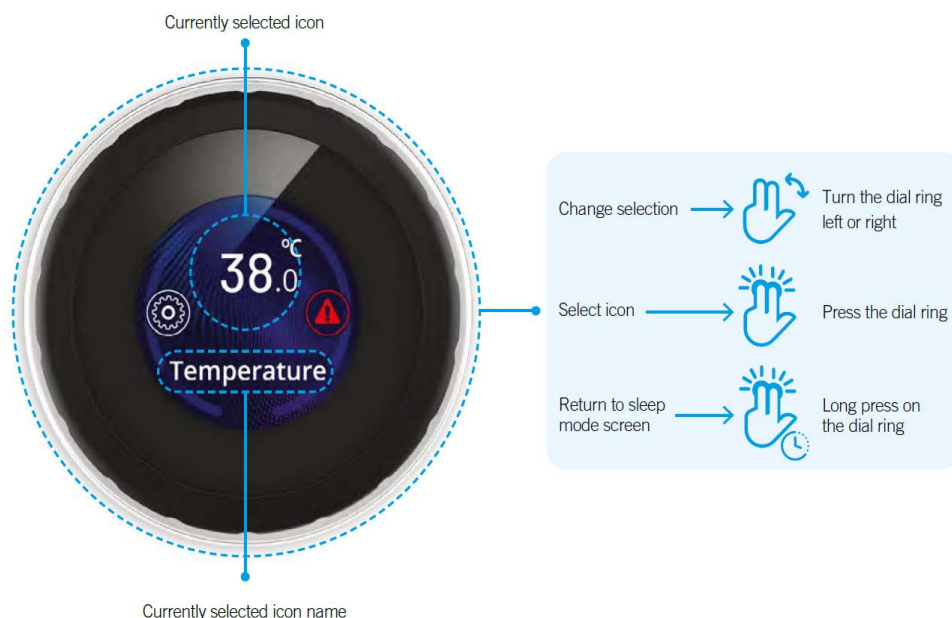

To navigate between functions and screens, the controller uses intuitive hidden physical switches to activate pumps, adjust settings, and operating other modes.

Use the rotating exterior bezel to navigate through options within the controller.

You may select an option by pushing down the control panel, the whole controller functions as one large button

VMS-1 variable-speed pump



Using the rotating bezel, you may find and select the Variable Speed Pump option. Press down on the controller to select this option. 39

You may use the rotating bezel to increase or decrease the spa pumps water flow.

Select "Massage" to see all available massage patterns within your throttle seat, the primary VMS Pump is labeled with a "1" in its icon.

Massage Menu

There are several different massage modes you can choose based on your preferences. Modes vary from rigorous water movement, to slow therapeutic rolling movements.



Once you have found your desired massage mode, press down on the controller.

Massage Adjustments



After selecting a massage mode within your Cal Spas Throttle Seat, you may fine tune your experience, by adjusting the pumps intensity or adjusting the rhythm of the massage to your preference.

Once you have fine tuned your desired adjustments, rotate the bezel to the name of the selected massage with "Press to start" displayed on the icon. Press down on the controller to begin the massage cycle.

- Once the massage type has been selected these pages will allow you to adjust the rhythm and intensity of your massage. Rhythm can be adjusted on 5 levels, intensity if set the same way as the in the menu of your variable speed pump, you can also start and stop your massage via this menu.



- You can press the flip display button to rotate the display 180 degrees.

Note: Certain options like "Lights" within this control system, are not intended to function. The throttle seat uses its own independent control system, the primary control system controls filtration, lighting, heating, and all other spa feature.



Settings

The settings menu gives you access to several different options to help operate your spa.

Note: The throttle seat is fully independent of the spa, changing certain settings within the controller will not affect the entire spas operation.

This Page is Intentionally Blank.

The Throttle Seat uses its own dedicated control box, using the powerful brains of the control system to provide reliable and consistent operation of the seats massage modes. Due to this some options appear within the spas control system, that are not actually present within the Throttle Seat.

This section provides some guidance on troubleshooting the Throttle Seat with its unique behavior compared to other control systems.

Note: The Throttle Seat control box does not receive commands from the main spa controller. The Throttle Seat control system only gets 220v power from the main control box terminal.

Problem	Solution
My Throttle Seat stays activated, even when the seat is not in use.	<ul style="list-style-type: none"> • The throttle seats set temperature is possibly raised above 60F. Lower the throttle seats temperature to 60F. The throttle seat does not contain an active heating system, this may confuse the pump system and can cause the throttle seat pumps to activate constantly. • Temperature adjustments in the Throttle Seat do not affect the heating temperature of the spa. • Keep the set temperature to 60F. Do not raise.
The Throttle Seat activates for a few seconds randomly every few minutes/hours.	<ul style="list-style-type: none"> • The throttle seats control system is currently conducting a purge cycle, this is considered normal operation if the pump remains activated for less than 60 seconds. • Verify the intensity % set on the Throttle seat is set to 0% when not in use.
How do I turn off the control screen when using the throttle seat?	<ul style="list-style-type: none"> • With your fingers/hand, press down on the display and hold for about 5-8 seconds. This will turn off the display.
Does the Throttle Seat have a filter?	<ul style="list-style-type: none"> • The throttle seat is designed to move large volumes of water at fluctuating rates, due to this the throttle seat is connected through a high flow suction fitting designed to prevent large debris and hair from entering the system. • Only the spas primary controller controls the filtration capabilities of the entire spa.

This section is intended for new spa owners who are not familiar with adjusting spa water chemistry. Everyone's knowledge with maintaining water quality is different, but there are some general concepts you need to know.

Water maintenance is not difficult, however it is something that requires regular attention. The most important thing to understand about taking care of your spa water, is that preventative action is easier than corrective action when balancing chemistry and maintaining water clarity

Before beginning, we recommend you become familiar with some water quality terms and their definitions within this following section.

1. Chemical Balancing

Learning how to properly balance your water.

You will need to test and adjust the chemical balance of your spa water, this is not a difficult task but it must be done regularly. Important areas to focus on with water chemistry is the calcium hardness, total alkalinity, and the pH range.

Spa owners with salt generators will need to perform a total dissolved solids and phosphate test.

3. Filtration

Learn how to properly clean your filter

Cleaning your filter cartridge is the easiest and most effective thing you can do to keep your spa water clear.

A clogged dirty filter will cause the heater and pump to work harder than they need to, possibly causing them to fail.

The spa's heating system will only function with the proper amount of water flow through the system.

2. Sanitation and Shock

Learning how to properly sanitize and shock your spa.

Sanitizers kill bacteria and viruses and keeps your water clean. A low sanitizer level will allow microbes to grow quickly in the spa water . We recommend using either granulated chlorine or bromine as your sanitizer.

You also need to add shock to the water to stimulate the chemical sanitizer. How much you use and how often you use sanitizers, depends on how frequently the spa is used.

4. Consistency

Make checking your spa part of your daily routine.

Clear water requires regular maintenance. Establish a routine based on a regular schedule, testing your water on a daily basis.

Maintaining your water quality helps the enjoyment of your spa and extends the lifetime of spa components by preventing damage from neglect and chemical abuse.

The following chemical terms are used in this section. Understanding their meaning will help you to better understand clear water maintenance. Words in bold type are defined in this table.

Bromine / Bromamines	<p><u>Bromine</u> is an efficient sanitizer chemical for spas. When used as a sanitizer, bromine forms compounds called bromamines. Bromine can be added to the spa or automatically generated.</p> <p><u>Bromamines</u> are compounds formed when bromine combines with nitrogen from body oils, perspiration, etc. Unlike chloramines, bromamines have no pungent odor and are effective sanitizers.</p>
Chlorine / Chloramines	<p><u>Chlorine</u> is an efficient sanitizing chemical for spas. We recommend using sodium dichlor-type granulated chlorine because it is totally soluble and nearly pH neutral. When used as a sanitizer, chlorine forms compounds called chloramines.</p> <p><u>Chloramines</u> are compounds formed when chlorine combines with nitrogen from body oils, perspiration, etc. Chloramines can cause eye irritation as well as having a strong odor. Unlike bromamines, chloramines are weaker, slower sanitizers. To remove chloramines, see the description of shock below.</p>
Calcium Hardness	Abbreviated as CH. Calcium hardness is a measure of the total amount of dissolved calcium in the water. Calcium helps control the corrosive nature of the spa's water and is why soft water is not recommended. The low CH level can cause corrosion to the equipment and can cause staining of the spa shell.
Corrosion	The gradual wearing away of metal spa parts, usually caused by chemical action. Generally, corrosion is caused by low pH or by water with levels of TA, CH, pH or sanitizer which are outside the recommended ranges.
Dichlor	Also called sodium dichlor. It is a type of chlorine and is frequently used when shocking the water . An effective chlorine -based powdered oxidizer and sanitizer . Dichlor works by oxidizing waste product in the water such as bromamines and chloramines and causing them to burn off.
Monopersulphate or MPS	Frequently used when shocking the water . An effective non-chlorine-based powdered oxidizer that works well with both chlorine and bromine . It works by oxidizing waste product in the water such as bromamines and chloramines and causing them to burn off.
Oxidizer	Shocking the water with an oxidizing chemical prevents the buildup of contaminants, maximizes sanitizer efficiency, minimizes combined chlorine and improves water clarity.
Ozone	Ozone is a powerful oxidizing agent which is produced in nature and artificially. Ozone forms no by-products of chloramines (ozone actually oxidizes chloramines) and will not alter the water's pH .
pH	The pH level is the measure of the balance between acidity and alkalinity. Low pH causes the water to be too acid, which will cause corrosion , whereas high pH causes the water to be too alkaline, which will cause scaling . See page for testing for and balancing pH.
ppm	The abbreviation of "parts per million", the standard measurement of chemical concentration in water. Identical to mg/l (milligrams per liter).
Sanitizer	Sanitizer is a chemical added to the water to kill bacteria and viruses and keep the water clean. The two sanitizers we recommend are chlorine and bromine

Scale	Rough calcium-bearing deposits that can coat spa surfaces, heaters, plumbing lines and clog filters. Generally, scaling is caused by mineral content combined with high pH . Additionally, scale forms more readily at higher water temperatures.
Shock	Also called shocking the water, shock treatment, or superchlorination. Shocking the water is adding significant doses of dichlor or MPS to oxidize non-filterable organic waste and to remove chloramines and bromamines . Shock treatment breaks down organic waste contaminants which cause odor and cloudy water.
Total Alkalinity	Abbreviated as TA. Total alkalinity is the measure of the total levels of carbonates, bicarbonates, hydroxides, and other alkaline substances in the water. TA is important for pH control. If the TA is too low, the pH will fluctuate out of control, and if it is too high, the pH becomes difficult to stabilize.
Trichlor	Used as a pool sanitizer . NEVER use trichlor in a spa. Trichlor is extremely acidic and will lower the pH , causing corrosion to equipment. Using trichlor will void your warranty.

Water Testing Methods

There are two testing methods to choose from:

Test strips are a convenient testing method commonly used by spa owners.



The reagent test kit is a method which provides a high level of accuracy but is more expensive and more difficult to use if not experienced with this testing method.



Adding Chemicals to the Spa

IMPORTANT: All spa water chemicals, including MPS (Shock), chlorine, granulated pH increaser or decreaser, granulated total alkalinity increaser, calcium hardness increaser, liquid stain and scale inhibitor, and liquid de-foamer must always be added into or in front of the filter compartment while the primary jet is running for a minimum of 10 minutes.

1. - Fold back the cover.
2. - Press the Jets button or Jet 1 button (Touch devices, activate pump 1)
3. - Carefully measure the recommended amount of chemical and slowly pour it into the filter area. Use care not to splash chemicals on your hands, clothes, eyes, or spa surface/siding
4. - Close the spa cover

Warning: High sanitizer levels can cause discomfort to the user's eyes, lungs, and skin. Always allow the sanitizer level to fall into the recommended range before using the spa.

IMPORTANT NOTE REGARDING SHOCK TREATMENT: After administering shock to your spa, leave the cover open for a minimum of 20 minutes to allow the oxidizer gas to vent into the atmosphere. A high concentration of trapped oxidizer gas which may exist as a result of the shock treatment (not daily sanitation) may eventually cause discoloration or vinyl degradation to the bottom of the cover. This type of damage is considered chemical abuse and is not covered under the terms of the limited warranty.

Balancing Water Chemistry Levels

Maintaining spa water chemistry can be tricky, especially since there are many methods of keeping your water clear and clean. Note: We do not recommend a specific brand of chemicals.

See a spa dealer for guidance and recommendations on spa chemicals and supplies needed, as water chemistry varies from region to region. Various chemicals often sold under brand names, but a spa dealer can advise you on generic chemicals that are often less expensive than proprietary brands.

Balancing the Total Alkalinity (TA)

Total Alkalinity is a measure of the total levels of carbonates, bicarbonates, hydroxides, and other alkaline substances in the water. TA is referred to as the water's "pH Buffer". In other words, it's a measure of the ability of spa water to resist chemical changes in the pH level.

If the TA is too low, the pH level will fluctuate widely from high to low. Fluctuations in pH level can cause corrosion or scaling of the spa components. Low TA can be corrected by adding sodium carbonate (pH/Alkalinity Up).

If the total Alkalinity is too high, the pH level will tend to be high, and may be difficult to bring down. It can be lowered by using sodium bisulfate (pH/Alkalinity Down).

Once the TA is balanced, it normally remains stable, although the addition of more water with a high or low alkalinity will raise or lower the TA reading of the water.

When the Total Alkalinity is within the recommended range, proceed to the next step.

Balancing the Calcium Hardness (CH)

Calcium Hardness is a measure of the total amount of dissolved calcium in the water. Calcium helps control the corrosive nature of spa water, that's why Calcium - low water (Soft Water) is not recommended. It is very corrosive to the equipment and can cause stains in the spa shell.

If the CH is too high (Hard Water) formation of scale on the spa shell & surface can result. You can use a generic calcium remover to remove hardness from water. CH can also be decreased by dilution (75% Hard water, 25% Soft water) will usually yield a reading within the correct range. If soft water is not available or practical for you, a stain and scale inhibitor should be added to the spa water, according to label instructions.

If the CH is too low, add CH Increaser.

Once the CH is balanced, it normally remains stable, although the addition of more water with a high or low calcium content will raise or lower the CH reading of the water.

When the CH is within the recommended range, proceed to the next step.

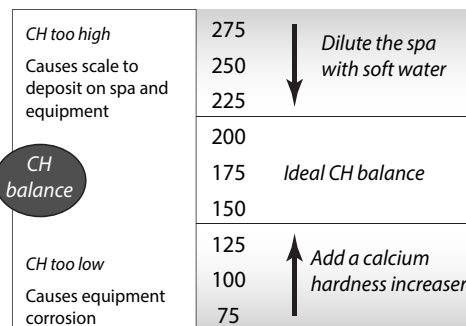
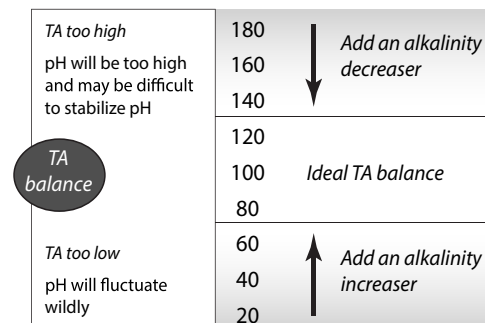

Balancing the pH

The pH level is the measure of acidity and alkalinity. Values above 7.8 are alkaline; those below 7.2 are acidic. Maintaining the proper pH level is extremely important for optimizing the effectiveness of the sanitizer, maintaining water that is comfortable for the user, and preventing equipment deterioration.

If the spas water's pH level is too low, the following may result:

The sanitizer will dissipate rapidly

- The water may become irritating to spa users
- The spas equipment may corrode
- Bacteria and algae spikes can occur.

If the pH is too low it can be increased with sodium hydrogen carbonate (pH/Alkalinity Up) to the spa water.

If the pH level is too high, the following may result:

- The sanitizer is less effective
- Scale will form on the spa shell surface and equipment
- The water may become cloudy
- The filter cartridge may become obstructed.

If the pH is too high, it can be decreased by adding sodium bi-sulfate (pH/Alkalinity Down) to spa water.

Note: After adding sodium hydrogen carbonate or sodium bi-sulfate, wait two hours before testing the spa water again for pH. Compounds take time to fully dissolve into the spa water, initial reading may not be accurate

Its important to check the pH on a regular weekly basis. The pH will be affected by the bather load, the addition of new water, the addition of various chemicals, and other sanitizer used. When the pH is within the recommended range, proceed to begin the sanitation process.

pH too high Too alkaline, causes scaling	8.2	↓ Add a pH decreaser
	8.0	
pH balance	7.8	↑ Add a pH increaser
	7.6	
	7.4	
	7.2	
	7.0	
pH too low Too acidic, causes corrosion	6.8	↑ Add a pH increaser
	6.6	

Sanitation and Shock

Sanitizers kill bacteria and other organic waste by breaking them down to non-harmful level which are filtered out. Before you fill your spa, you need to decide which chemical sanitizer you wish to use. Consult your Cal Spas dealer for the right decision with regards to your lifestyle and spa usage.

We recommend granulated chlorine or bromine as your sanitizer. Both work well when maintained regularly

Note: DO NOT USE Trichlor. Trichlor is very acidic and the hot temperature of the spa causes it to dissolve too fast, it will cause damage to your spa and will void your warranty.

Whichever chemical you decide to use, do not take shortcuts. It will provide you with clean, safe, clear, spa water with a minimum of effort. Spa owners with an ozonator still need to use a chemical sanitizer. Whenever you test chemical levels, your test strip will likely have a test for chlorine or bromine. Make sure you sanitizer falls within the range shown on the next page.

Whenever you test your chemical levels, your test strip will likely have a test for chlorine or bromine. Make sure your sanitizer falls within the range shown on the next page.

If your spa is equipped with a ozonator, this will assist in breaking down organic material and odors, but it will not disinfect your water, following the standard ppm recommendation for the sanitizer of choice is mandatory.

After you choose a sanitizer, you will need to establish a baseline and maintain it regularly.

Sanitizing your spa with chlorine or bromine is very similar. Each sanitizer has its advantages and disadvantages. Sanitizer helps neutralize bacteria that can cause illness and other organic matter.

Bromine: Creates less odor and skin irritation than chlorine, bromine is less likely to do so. Additionally, unlike chlorine when bromine combines with bather waste and other contaminants in the water it remains an effective sanitizer. Bromine is also far less pH dependent than chlorine. Always remember that bromine itself is not a sanitizer, it needs to be activated with a bromine shock chemical in order to be effective, speak with your spa dealer for more information.

Chlorine: The most commonly recognized sanitizer is chlorine. However, the effectiveness of chlorine depends heavily on the pH level of the spa water. In order to get the most effective and economical benefit of chlorine, you must maintain a consistent pH level of between 7.2-7.6; a disadvantage of using chlorine is that when chlorine combines with bather waste and other contaminants, not only does it lose its sanitizing ability, it can cause odors and irritate eyes and skin to individuals with sensitive skin or prolonged spa exposure.

Testing For:	Ideal Range (ppm)	
	Minimum	Maximum
Chlorine Level	3.0 - 5.0	
Bromine Level	6.0 - 11.0	

Note: If you choose to use bromine or chlorine we do not recommend the use of a floater. You have more control over the sanitizer levels by adding sanitizer as needed. Chemical abuse will void your warranty. When adding sanitizer to your spa, ensure that pump one is operating at high speed, and feed the sanitizer into the filter canister with the most suction, for spas with more than one pump we recommend activating all pumps for at least 10 minutes when adding sanitizer.

Starting with fresh water/pre-filtered well water:

1. Establish a baseline by adding either granulated chlorine or bromine.
 - Use a half ounce of chlorine for every 500 gallons of water
 - Use half an ounce of bromine for every 100 gallons
2. Run the Jets for 10 minutes (Press/toggle the pump 1 button/icon)
3. Test the water, make sure the pH, TA, and CH levels all fall within the ranges shown in the previous pages, make adjustments as needed.
4. After balancing the water, if you are using bromine to sanitize your spa, you must activate your bromine. You will need to shock-oxidize the bromine inside of your spa. Depending on the size of your spa, usually you must add one to two ounces of shock, refer to the instructions inscribed in your chemical of choice.
5. Test the water again, when the water is balanced, your spa is ready to use.

Shocking the Water

In addition to using a chemical sanitizer, you will periodically need to shock the water. Shocking the water helps remove burned-out chemicals, bacteria, and other organic material from your spa's water and improves your sanitizer's effectiveness.

Do not use chlorinating shock, which can damage the spas jets and pump seals. Only use Oxidizer shock. It can be used with either bromine or chlorine sanitizers.

Add two ounces of oxidizer shock per 500 gallons once a week, after heavy bather loads, or if the water has a strong odor. The spa must be running with all of the jets on high for 30 minutes with the cover open. If necessary repeat the oxidizer shock in 30 minute intervals.

Filtration & Cleaning

The filter is the part of your spa that removes big and microscopic debris from the water to maximize your spas water clarity. Regular maintenance must be done to maximize the spas filtering performance and heat efficiency.

It is extremely important that you never run the spa without a filter, there is a possibility that debris may be sucked into the plumbing, damaging the spa pumps and heater.

Cleaning the Filter

In addition to spraying the filter down with a hose to remove surface debris, the filter must be deep cleaned every so often to dissolve scale and particles that are trapped within the pleats of the filter. Even if the filter looks clean, scale and other particles hide deep within the filter fibers restricting water flow. If the filter is not properly cleaned this will cause flow issues within the spa heater creating a heater malfunction. We recommend cleaning your filter at least once a month or every two weeks depending on spa usage.

Cleaning the filter

1. Remove the filter by unscrewing the filter counterclockwise from the top of the filter, do not use excessive force when removing or installing the filter.
2. Place the dirty filter into a bucket of water where the filter is completely submerged in water. Add the desired filter cleaner of choice, on average most manufactures recommend 8 ounces of chemical cleaner, verify the amount used on your chemical instructions.

Note: It is recommended to obtain a spare filter to use in the spa when performing maintenance on the dirty filters. This way you can rotate the filters and extend their lifespan.

3. Soak the filter for a minimum of 24hrs
4. Spray the filter with a water hose, with careful attention between filter pleats.
5. Reinstall the filter, Do not over-tighten.

Prior to each use	Test the spa water. Adjust chemical levels as necessary. Shock the water by adding ½ teaspoon of sodium dichlor per 250 gallons or 1 teaspoon of MPS per 250 gallons.
After each use	Add an ounce of oxidizer after heavy bather loads
Once a week	Check the filter well and inside the filter pipe for leaves and foreign matter. Test the spa water. Adjust chemical levels as necessary. Shock the water by adding ½ teaspoon of sodium per 250 gallons or 3 teaspoons of MPS per 250 gallons. If your water source is high in calcium, add stain and scale preventer.
Every two to four weeks	Deep clean your spa's filter. How often you clean your filter depends on how much you use your spa. There is no harm in frequently cleaning your filter and will only help your spa's efficiency.
Every two to four months	Change the spa water. How often you change the water depends on how much you use the spa. When you change the water, you will need to: <ul style="list-style-type: none"> • Clean and polish the acrylic surface • Clean and treat the spa cover and pillows • Deep clean the filter • Refill your spa
Each time you refill the spa	Follow the section "Filling and Powering Up Your Portable Spa"

Generic Names for Chemicals

Water Chemistry		
Common name	Usual chemical name	Common brand names
pH Up	sodium hydroxide	pH Increaser, pH Up, pH Plus, pH Booster
pH Down	sodium bisulfate sodium bicarbonate (baking soda) sodium carbonate	pH Decreaser, pH Down, pH Minus, pH Subtractor, Dry Acid
Alkalinity increaser	sodium carbonate sodium bicarbonate (baking soda)	Alkalinity Increaser, Alkaline Up
Alkalinity decreaser	sodium bisulfate	Alkalinity Decreaser, Alkaline Down
Calcium increaser	calcium chloride	Calcium Increaser, Calcium Up, Calcium Plus, Hardness Increaser
Calcium decreaser	N/A To decrease calcium hardness, drain several gallons of water from the spa and refill using a mixture of 75% hard water and 25% soft water, or use a stain and scale inhibitor.	

Sanitizers

Common name	Usual chemical name	Common brand names
Chlorine	sodium dichlor	Both chlorine and bromine are available under numerous brand names
Bromine	sodium bromide	

Shock

Common name	Usual chemical name	Common brand names
MPS	monopersulphate	MPS Shock, Oxy-Spa, SeaKlear
Dichlor	sodium dichlor	Dichlor Shock

Note: Dichlor (chlorine) is both a sanitizer and a shock. Monopersulphate (MPS), when used as a shock, can be purchased alone as non-chlorinated shock or combined with dichlor, which makes it significantly more effective than MPS alone.

Other chemical additives

Common name	Usual chemical name	Common brand names
Stain and scale inhibitor	These are usually proprietary chemical formulations and cannot be purchased as a single generic chemical.	Metal Stain Gone, Scale Inhibitor, Stain and Scale Preventer, Stain and Scale Defense
Foam inhibitor		Foam Gone, Foam Down, Defoamer
Clarifier		Water Brite, Spa Bright, Water Clarifier, Clear Water, Natural Clarifier, Brite & Clear

Do NOT use these in your spa:

- Sodium hypochlorite (household bleach)
- Trichlor

Common Water Chemistry Questions

Question : Why is the use of a floater not recommended to sanitize my spa water?

Answer: We do not recommend the use of a floater for three reasons:

- The floater is unable to control the rate at which the sanitizer is dissolved into the water. When a floater is placed into a spa the sanitizer levels inside the spa can be extremely high. High sanitizer levels over a period of time will cause chemical burns and discolor the spa shell, jets, pillows, and spa cover underside. The use of floaters tends to lead to negligence of spa water sanitizer levels as well. Once the sanitizer is all dispensed and the floater is not checked daily, the low sanitizer level will allow viruses, algae and harmful bacteria like Legionella (Legionnaires disease) and E-Coli to grow.
- Floaters tend to stay in one area of the spa most of the time, causing this area to be exposed to extreme sanitizer levels. Most commonly a floater will become trapped near the filter weir or a seat, causing chemical damage to the section of the spa.
- The floater may allow small chunks or pieces of the concentrated sanitizer to fall out of its housing causing the chunks to settle at the bottom, causing pitting or chemical blisters to the spa shell. For this reason we advise you to use granulated chlorine or bromine as granulated sanitizers are designed for dissolve quickly inside of the spa with your jets activated. Chemical abuse is not covered under the terms of the limited warranty.

Question : When I open my spa, I smell chlorine. How to I get rid of the smell?

Answer: There are two types of chlorine in your spa. the first is "Free Chlorine" which is chlorine molecules that are available to sanitize your spa. This free chlorine does not have an odor. The second is chloramine, which is a byproduct of chlorine that has already been used/expended to sanitize. Chloramines generate the strong chlorine smell most spa owners experience. This can be eliminated by shocking your spa water, if you smell chlorine in the water, its time to shock.

Question: Why can't I fill my spa with soft water?

Answer: Soft water is essentially the same as regular water except in one regard that is important for spa chemistry and that is calcium levels. The calcium inside of the water has been replaced by sodium, which can be corrosive to heaters, pumps, and other plumbing equipment which will become expensive to replace. Calcium is needed for certain chemicals to properly function as well. Only use potable water that has not been treated with a water softener.

Question: I am concerned about the amount of chemicals my family is exposed to, do I really need to use as many chemicals in large amounts?

Answer: While there should be concern of over exposure to any chemical being unhealthy, spa chemicals when used correctly are designed to be effective and beneficial. In the case of spa water, the chemicals we recommend are important to protect the user from waterborne illness, including skin infections and disease causing pathogens, chemicals also help to prevent corrosion of spa components.

Question: Why isn't water chemistry damage (chemical abuse) covered under warranty?

Answer: The chemical levels and water quality of the water in the spa are directly under your control. With proper basic care the spa will provide many years of hot water relaxation. If you are unsure about water chemistry, reach out to your spa dealer.

Do's and Dont's

- Do add chemicals slowly into the front of the filter compartment/weir with jet one operating for at least 10 minutes.
- Do use special care if using baking soda to clean either the interior or exterior plastic surfaces.
- DON'T use swimming pool muriatic acid to lower pH.
- Don't splash pH increaser additives on the siding.
- **Don't Use compressed sanitizers**, The use of bromine sticks or tablets in floaters may become trapped in a lounge or cooling seat, and in some cases sink to the bottom of the spa. This may cause discoloration or stress on the spa shell.
- Don't use a floater type sanitation system as a low or no maintenance solution to your spa maintenance. Floating dispensers can become trapped in one area and cause an over sanitation (or chemical burn) of the particular area, damaging acrylic, jets, and pillows. If the dispensers setting is too high, the higher concentration can also cause chemical burn damage throughout the spa. This kind of chemical damage can be done by both bromine and chlorine sanitizers.
- Don't use a sanitizer which was not designed for spas.
- Don't use household bleach (liquid sodium hyperchlorite).
- Don't broadcast or sprinkle the chemicals onto the water surface. This method can cause chemically induced blistering on the spa surface (chemical abuse).

Bather Load

“Bather Load” is the term used to describe the number of people using a spa, combined with the length of usage, and the frequency of usage. All these factors have a great effect on the spa water. The higher the bather load, the more chemicals need to be added and a longer filtration time will be needed.

Recommendations are designed for spas with average bather load (3 to 4 people=, 15 minutes of usage, three times a week at 100 degrees). If your bather load exceeds these guidelines, and you experience water quality problems, increase the amount of filtration first, (go to the next higher filtration number) then if water quality is still not adequate, consult the advice of your Cal Spas dealer for additional chemical or system recommendations. Be sure to give them your bather load information.

Ozonator

The ozone generator releases ozone into the spa water. You will still need to test for chlorine/bromine and occasionally replenish it to return the sanitizer level back to baseline. **For spas without a circulation pump, “Pump 1” will run at low speed and the ozonator will run during filtration.**

The spa’s control system is factory programmed with one filter cycle that will run in the evening, aligning with lower energy rates in that time slot. The time and duration of the filter cycle can be set according to your needs. In addition, a second filter cycles can be enabled. Filtration time may need to be increased with a heavy bather load.

Make sure water diverter valves are turned all the way to the left or right, and never left in the center position during filtration cycles. When the diverter valve is in the center position, there is not enough suction from the pump in order to inject ozone into the spa. The ozonator will generate ozone, but it would not be injected into the water effectively.

Troubleshooting Water Clarity

Problem	Probable Causes	Possible Solutions
Cloudy Water	<ul style="list-style-type: none"> • Dirty Filter • Excessive oils/ Organic matter • Improper sanitation • Suspended particles/organic matter • Overused or old water 	<ul style="list-style-type: none"> • Clean filter • Shock spa with sanitizer • Add sanitizer • Adjust pH and/or alkalinity to recommended range • Run jet pump and clean filter • Drain and refill spa
Water Odor	<ul style="list-style-type: none"> • Excessive organics in water • Improper sanitation • Low pH 	<ul style="list-style-type: none"> • Shock spa with sanitizer • Add sanitizer • Adjust pH to recommended range
Musty Odor	<ul style="list-style-type: none"> • Bacteria or algae growth 	<ul style="list-style-type: none"> • Shock spa with sanitizer • Adjust pH to recommended range

Problem	Probable Causes	Possible Solutions
Organic Buildup/ Scum Ring Around Spa	<ul style="list-style-type: none"> • Buildup of oils and dirt 	<ul style="list-style-type: none"> • Wipe off scum with clean rag - if severe, drain the spa, use a spa surface and tile cleaner to remove the scum and refill the spa
Algae Growth	<ul style="list-style-type: none"> • High pH • Low sanitizer level 	<ul style="list-style-type: none"> • Shock spa with sanitizer if problem is visible or persistent, drain, clean and refill the spa
Eye Irritation	<ul style="list-style-type: none"> • Low pH • Low sanitizer level 	<ul style="list-style-type: none"> • Adjust pH • Shock spa with sanitizer and maintain sanitizer level
Skin Irritation/ Rash	<ul style="list-style-type: none"> • Unsanitary water • Free chlorine level above 5ppm 	<ul style="list-style-type: none"> • Shock spa with sanitizer and maintain sanitizer level • Allow free chlorine level to drop below 5 ppm before spa use
Stains	<ul style="list-style-type: none"> • Total alkalinity and/or pH is too low • High iron or copper in source water 	<ul style="list-style-type: none"> • Adjust total alkalinity and/or pH • Use a stain and scale inhibitor
Scale	<ul style="list-style-type: none"> • High calcium content in water - total alkalinity and pH too high 	<ul style="list-style-type: none"> • Adjust total alkalinity and pH - If scale requires removal, drain the spa, scrub off the scale, refill the spa and balance water • Use a stain and scale inhibitor

Chemical Abuse

Chemical abuse is defined as negligent/careless use of both recommended spa chemicals, and use of prohibited chemicals. The spa shell is designed to last for many years, but when the shell is exposed to excessive chemicals, or improper chemical application; this can cause reactions on the shell that can cause pitting, cracks, bubbling, and other blemishes on the shell.

Spa jets, pillows, and other components are designed to withstand sanitizer levels within the range mentioned in this manual. Excessive sanitizer use will cause oxidation of the interior of the spas metals and other components, which can cause rust/oxidation of jets, deterioration of spa pillows, speakers and plastics, and damage/oxidation of the spa cover.

Components & materials damaged by chemical abuse are not covered under warranty. Depending on the extent of damage the entire spa warranty can be voided, as stated in the limited warranty.

Cal Salt Filtration Plus, Sanitation System

The Cal Salt Filtration Plus is a premium sanitation system combining a Gecko bromine generator considered one of the best in the industry, along with a circulation pump designed to filter the water in your spa for 24hrs a day. The bromine generator releases bromine into your spa water, rapidly destroying bacteria, organic matter, and algae within your spa. It eliminates the need to add bromine or chlorine in a regular basis by using bromine salts to release activated bromine throughout your spa.

When sodium bromide (ex BromiCharge) is added to the water, it separates into sodium ions and bromide ions once it passes through the bromine generator. This releases activated chemicals that will target bacteria, algae, and other organic matter



Note: In your Platinum or Escape X Cal Spa, the Cal Salt Plus controls are integrated within your main spa controller.

Refer to page 59-60 to help you navigate through the sanitation software.



Warnings! Important safety instructions

- For Canada, in.clear (using Bromitron Bromine Generator Technology) must only be used with sodium bromide (such as BromiCharge) scheduled or registered under the Pest Control Product Act. For USA, the sodium bromide (such as BromiCharge) must be registered under EPA.
- Read and follow this manual carefully and make sure to save it for later. This manual contains important information on in.clear's installation, use and safety recommendations. It is your responsibility to install and use your in.clear unit safely.
- The in.clear must be connected to a circuit protected by a ground fault interrupter device (GFCI) in North America or residual current device (RCD) having a rated residual operating current not exceeding 30 mA in Europe.
- Make sure all electrical power is off before installing the in.clear unit. If the supply cord is damaged, it must be replaced by the manufacturer, its service agent or similarly qualified persons in order to avoid a hazard.
- Use only an electrical cord in good condition to power the in.clear.
- Follow all aspects of the local and National Electrical Code(s) when installing the in.clear Automatic Bromine Generator.
- Always clean or replace your filter cartridges at regular intervals, otherwise part of the bromine generated by in.clear will only serve to oxidize the dirt accumulated in the filter.
- Do NOT add any other sanitation chemicals in the spa other than registered sodium bromide (such as BromiCharge).
- Do not add chemical products for pool or spa directly into the skimmer. This may damage the cell.

Important Salt System Information

Your spa is equipped with one of the most recent innovations in spa sanitation, the in.clear bromine generator system. This is a sanitation system that contains a bromine generator, that activates bromine to provide sanitizer for your spa. It does this through the process of Electrolysis, using bromine salt water to charge and release bromine during the spas filtration process.

 **READ & FOLLOW ALL INSTRUCTIONS CAREFULLY WITHIN THIS GUIDE**

Water Prerequisites

The bromine generator is only able to function if the spas water is within certain parameters. Hot tubs that are filled with water from municipal sources, are required to use a disposable attachable hose pre-filter. Pre-filters help remove the nominal levels of TDS materials that can exist in water. Never fill a salt water spa with well water, or water treated with a water softener as TDS (Total Dissolved Solids) levels are much higher from these sources than in normal municipal water.

TDS (Total Dissolved Solids), are a combination of dissolved metals such as minerals, salts, and other metals that are commonly found in well water sources, and introduced into water through water softener systems. TDS levels in municipal water is much lower than in well water or homes using water softener systems. This is due to the regulation and regular testing of municipal water sources provided to residents and businesses. The water sources must be safe for high pressure systems, boilers, and machines connected to the main municipal water lines.

 **Warning: Never fill a spa with well water, or water that has been treated with a water softener, Damage done to salt cell system from failure to follow this warning, is not covered by the limited warranty of the spa.**

 **Warning: Do not use other sanitation chemicals (Including Shock) other than the sodium bromide inside of the spa.**

Water Parameter to Monitor	Required Value
Total Hardness	50 - 400 ppm
Calcium Hardness	150 - 200 ppm
Total Alkalinity	100 - 120 ppm
pH	7.2 - 7.8

Fill Up Procedure

The following section will explain and illustrate how to properly fill your salt water spa. This includes the process of filling, activating jets, and disbursing salt throughout the spa.

Note: Always fill the spa through the filter basket, and always use a pre-filter. Never power on a spa when the water is not at the recommended water level, or without water.



Caution: Never fill the spa with well water or water treated by a water softener system.

1. First obtain your hose and attach a pre-filter to the hose. These pre-filters are commonly sold in pool & spa supply stores. Your spa dealer may have included such a filter with your spa, contact your spa dealer to obtain a pre-filter hose attachment for your spa. If the spa is placed in areas where water hardness is known to be high, we advise to attach two pre-filters onto the hose.



2. Place the hose with the pre-filter attached into the filter basket and begin to fill the spa. Filling the spa through the filter canister will avoid airlocks from appearing within the plumbing of the spa. Never fill the spa anywhere else but through the filter canister when the spa is new or freshly drained.



3. Once the spa is filled, obtain test strips to check the baseline values of the spa water, using the prerequisite table from the first page. If a water parameter is out of range, the use of chemicals such as “pH down” or “metal out” may be used to adjust water chemistry if necessary, after priming all spa pumps.

4. Flip the power of the spa on from the GFCI breaker to the on position, and activate all pumps within the spa. This will push out any air pockets trapped with the plumbing, In the off chance that a pump encounters an airlock, you can follow the air bleeding guidance on the spa owners manual, and turn off the spa. Once the pump or plumbing has been bleed, power the spa back on and activate the affected pump to prime it. Observe is water movement happens when each pump is activated one at a time. The Circulation pump will always run with slow water movement, once 24hr filtration is set up.

 **Caution:** Never allow a spa pump to run dry for more than 45-60 seconds. This can cause damage to the impeller, motor, and rings inside of the pump. Pumps that have failed due to running dry, are not covered by the spas limited warranty.

5. After priming and/or bleeding of the pumps within the spa. Proceed with setting up the 24hr filter cycle on the ink1000 control panel.

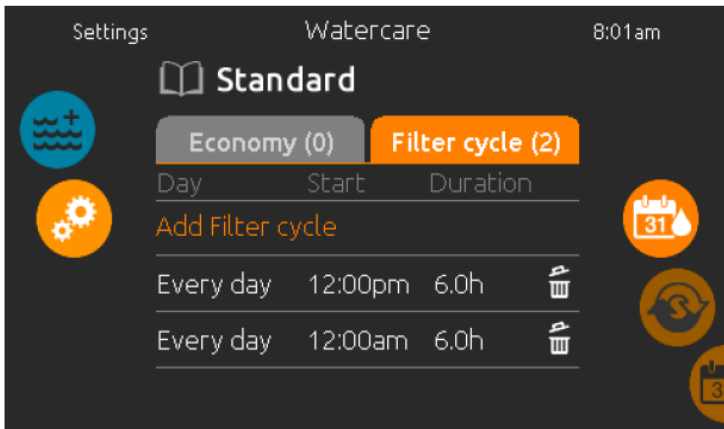

Additional control panel information can be found on page__ within this owners manual.

Select the preferred water care & energy mode, and configure the filtration duration. Spas equipped with a 24hr circulation pump, set the time from 12am to 12am. This way the controller understands that you wish to initiate the 24hr filtration system

Within this menu you find two tabs one for filter cycles and one for economy. These tabs allow you to fine tune spas behavior. There is not real need to modify the Economy Tab unless its intended to be left alone for a period of time.

6. Once the Filtration is set, obtain the proper amount of bromine salt needed for the spa. The ratio needed for salt in your spa is 1.2 lb of salt per 100 gallons (0.54 kg/378.55 L). Spas ordered with our pre-installed bromine generator, includes two 3.5 lb containers of Sodium Bromide.

7. Once you have calculated the amount of salt needed for your spa, activate all of the spa pumps on high speed. Using the cap on the bromine container, fill the cap and sprinkle the bromine salt throughout the spa until the amount needed has been disbursed.



Note: if the spa water is less than 70°F its recommended to activate the heater of the spa until the spa reaches 70°F or above to help dissolve the bromine salts.



WARNING: NEVER PLACE SALT DIRECTLY INTO THE FILTER CANISTER, WATERFALLS, OR DIRECTLY INTO THE PLUMBING OF THE SPA. DOING SO WILL VOID YOUR SPA WARRANTY.



Allow all spa pumps to run for the next 10 minutes to fully dissolve the salt into the spa water.

- 8. Once the salt has been diluted access the in clear icon from the main ink.1000 control panel. Within this screen we will activate boost mode. Boost mode must be used when the spa is first set up, when its refilled, and after using the spa. The following section will explain basic navigation and explanation to the in.clear system within the ink.1000 display.

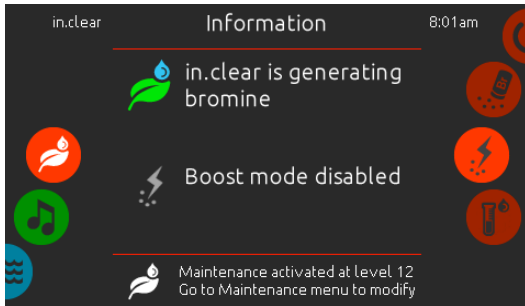

in.clear functions

This menu is available only if the in.clear is detected in the spa accessories.

The in.k1000+ keypad can be used with the in.clear sanitation system.

The *in.clear* menu allows you to configure your maintenance settings and boost levels. The main *in.clear* menu shows the current status of the sanitation system, whether it is on and if it is generating bromine or not.

For more information about the in.clear, bromine levels and other settings, please refer to the in.clear user manual.

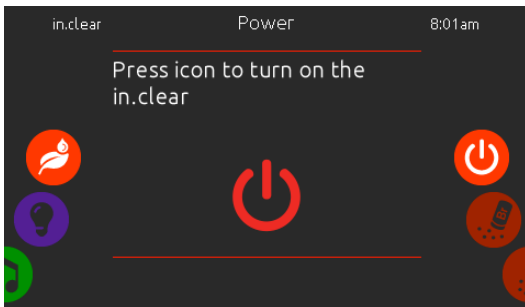

in.clear on/off

A 5 second press on the power down key is required to turn off the in.clear. This prevents accidental desactivation of the sanitation system.

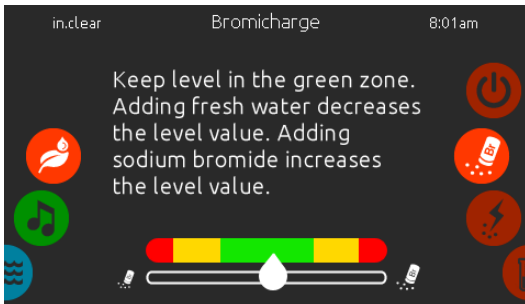

Bromicharge™ level

The Bromicharge page allows you to see the current level of sodium bromide in the water. Ideally, you should aim to be near the center of the green area of the gauge. Follow the instructions given on the screen to increase or reduce the level.

Note that it may take a few seconds to obtain a reading from the in.clear, during this time the wait icon is displayed on the gauge.

There are no settings to change on this page, it is solely informative.

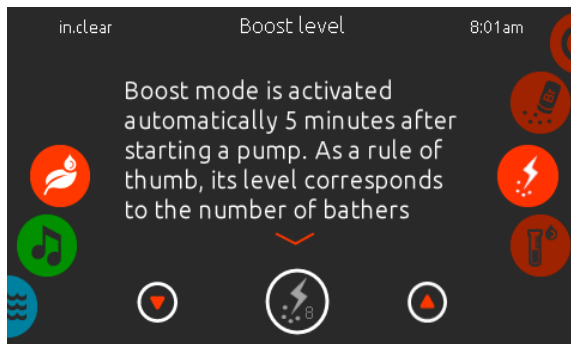

Modify the Boost level

The Boost level is used to set the amount of boost required. As a rule, enter the number of bathers in the bath. Boost mode is automatically activated 5 minutes after starting a pump.



Warning: Every time the spa is filled with new salt water, Boost mode must be activated each time. Days in order for the cell to activate and maintain bromine levels in the spa.



Warning: Do not use the spa until a period of 24-48 hrs has passed. Test the spa water regularly, do not use the spa until bromine is stable between 3-5ppm within this time frame.

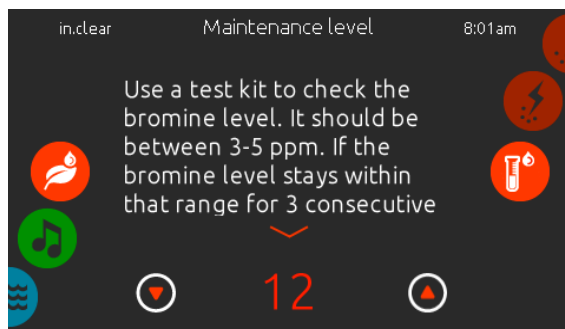

Modify the maintenance level

The maintenance level can be changed and must be tested with a bromine level tester. The tester should report between 3-5 ppm. If the bromine level is within this range for 3 consecutive days your maintenance level is correctly adjusted. If you adjust the maintenance level by more than 2, you will be prompted to confirm.

Common Care & Troubleshooting Procedures

Long Bromine Recovery Time

- Activate "Boost Mode" at the appropriate level every time after you use the spa.
- Heavy bather loads will require longer boost periods. If bromine level is below 3 ppm following a boost period, press "Boost Mode" again to bring the bromine bank within 3-5 ppm. This can happen for a number of reasons, but the best way to avoid having to repeatedly boost the spa, rinse off before entering the spa, not only will this help keep your bromine levels in check, but will also maintain and improve water clarity.
- If a high boost or a repeated boost does not increase your bromine levels, increase the amount of time your filter cycles operate for.
- If bromine production is still inadequate after following all the previous recommendations, biofilm deposits can be causing the lack of bromine, using flushing products such as Swirl Away, Sea Klear, or National Chemistry Spa Purge can be effective in removing biofilm. **A full drain and refill is needed.**

Low or No Bromine Level Detected

- Make sure the maintenance level is properly set according to the procedure described in the section Set Maintenance Level. Make sure there is no error or warning message on the display, the cell is activated and that water is circulating properly through the cell.
- Make sure that your water chemistry is balanced, improperly balanced water will cause the bromine generator to not operate properly.
- Phosphates can impact the distribution and activation of bromine inside of your spa. Phosphate levels should never exceed 100 ppb. Phosphates are found in body lotion, sunscreens, perfume/deodorant, soaps, and household cleaners.
- Restricted water flow can cause a drop in bromine generation as well. Make sure that the filter has been soaked and cleaned with a filter cleaner. If it is a heavily soiled filter or old filter (more than 12 months old) replace the cartridge.

Cleaning Procedure for Scale Removal

The bromine generator includes a self cleaning feature to prevent scale deposits on the graphite electrodes of the in.clear system. However hard water can still cause these deposits to form, if that happens the cell should be cleaned in an acidic solution. **This cleaning should be done by a trained service technician** as handling phosphoric acid can be hazardous for your health.



Precautions when handling phosphoric acid



- Wearing eye protection and rubber gloves, when handling acid. Splashing and spilling can cause severe chemical burns, personal injury, and property damage
- Technicians must always work in a well ventilated area.
- Always add acid to water, never pour water into acid. This can cause an exothermic reaction causing a small explosion or boil over, splashing and spilling acid around the vicinity of the occurrence.
- Never pour acid outside of the unit where connections are located.
- **Never use acetic acid to clean the cell**, this will cause permanent damage to the cell components, voiding warranty

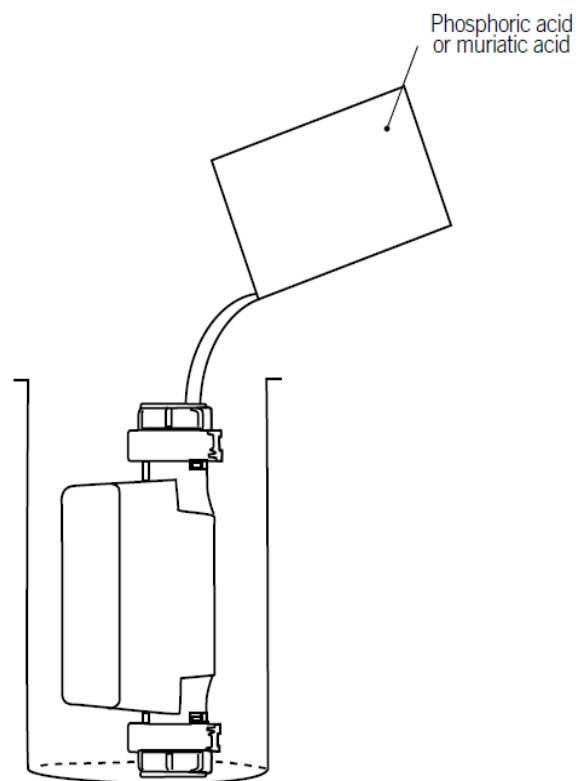

Maintenance Level Information

- Spas built with a 8 x 8 frame typically use a maintenance level between the ranges of 16-21.
- Spas built with a 7 x 7 frame typically uses a maintenance level of 12-18.
- Always activate boost mode after using the spa, and increase/decrease the boost level based on the number of people that used the spa (**3 people = Lv 3 boost**)

1. To remove scale from the cell, use phosphoric acid (non diluted). Close the spa gate valves and unscrew both unions from the unit and remove the cell from the spa equipment compartment.
2. Install the rubber washer and the plastic nut on the threaded end of the cell. Tighten it firmly
3. Place the cell in a 5 gallon bucket vertically as show in the illustration 2.01, slowly and carefully pour the acid solution inside the cell until the 4 plates inside of the cell are covered in acid (avoid overflowing). The acid will create a foam once it begins to react with the deposits on the graphite plates. if there is no foaming action then the cell does not need to be cleaned. Pour out into the bucket, rinse and re-install the bromine cell.
4. If foaming does occur allow the foaming process to slow down and finish, however do not leave the cell in acid for more than 15 minutes, anything past 15 minutes will damage the cell, voiding any warranty on the component.
5. Pour out the used up acid from the cell back into the bucket, thoroughly rinse the cell with clean tap water.
6. Remove the plastic nut and washer from the cell and keep them for future cell cleaning.
7. Thoroughly rinse the in.clear system with fresh water, and re-install onto the spa.
8. Once securely mounted, reconnect the keypad and power cable, turn the power back on to the spa and resume normal operation.

The regularity of this procedure depends on water quality in the spa, follow the specified water requirements within this manual.



Water Lab (Option)

The water lab is an add on option for a variety of Cal Spa models, and comes standard with Platinum Edition Spas. The water lab is a revolutionary piece of technology that allows spa owners to monitor and correct water problems with high precision sensors allowing owners to see what chemicals or general actions are needed to maintain proper water chemistry.

Purposely designed sensing chamber for seamless under-the-spa inline integration

High-durability probe ensures minimal under-spa intervention

Simple installation in deviation line allowing for multiple possibilities

Extended-life sensor minimizes replacement cycles to once every 4-years

Avoid extra burden to regular spa maintenance such as drainage and winterization

All-in-one, high-precision sensors that monitor your water acidity, temperature, and sanitation.

Engineered to maximize probe life with an always-wet design and reduced water flow

Minimize calibration to once over the lifetime of the probe

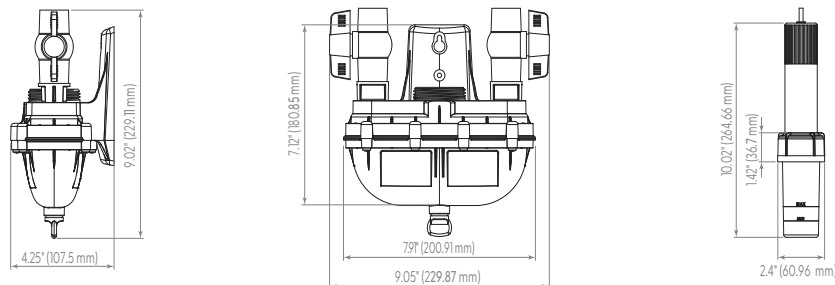

The water lab equipment is pre-installed inside of your spa if the option was selected. This module communicates directly with the Gecko wifi system known as the **in.Touch 3 Wifi system**. The wifi system uses a secondary module called the **CO module** to communicate with all smart devices inside of the spa.

This feature only works through the Gecko Spa App that can be downloaded on the google play store or Apple App Store. The set up process of the Gecko Wifi in.Touch 3 must be completed before using the water lab.

The following pages will illustrate and explain, how this Water Lab module is connected inside of your spa. Showing the set up of using the in.touch 3 wifi system, general operation and troubleshooting information.

CO module (Spa) installation

A

Prior to any installation procedures, turn off the power of the spa

Install the CO module unit under the hot tub skirt as high as possible in a corner facing towards your home router.

The CO module should be at least 12" (30 cm) from any metal component or structure.

This is necessary to ensure optimal transmission. In some cases, it may be necessary to relocate the unit once the spa is installed in the yard to guarantee proper signal transmission and distance.

B



Screw the CO module with a #8 pan head screw and leave some slack on the cable

This will enable the module to be repositioned to optimize the signal strength in the yard.

C

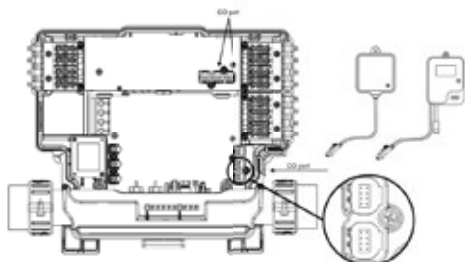

Connect the CO module into an available CO port of the control system

Note that the CO module only has a single CO cable and must be installed at the end of the CO chain if more than a single accessory is installed on the same CO port of the control system.

EN (Home) installation

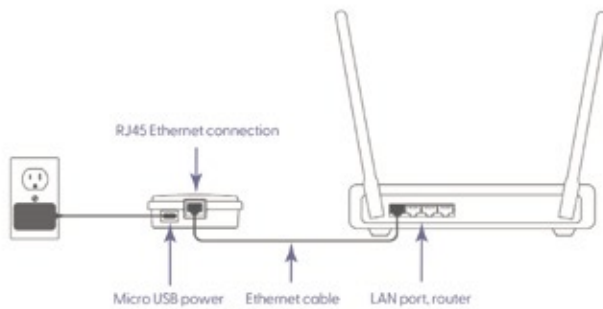

To allow communication between the CO and EN module, the EN module needs to be installed on a router.

1

Connect the power supply of the EN module.

2

Connect your home router to the EN module using the LAN port with the ethernet cable.

Installation of the chamber in the spa

The water lab uses cartridges that react with impurities and triggers sensors inside of your spa. The following section illustrates how the cartridge is installed for replacement..

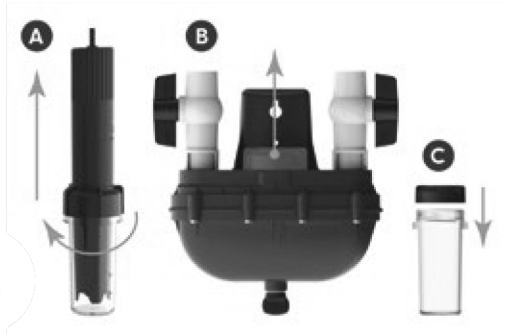

- A- Remove the probe from its storage bottle
- B- Remove the top cover of the chamber
- C- Screw it on top of the storage bottle once the probe has been removed

Important notice :

- The probe must be kept in temperature above 0°C (32°F)
- The probe must avoid long air exposure (over 15 min)



Slide the probe in the chamber and hand-screw the nut

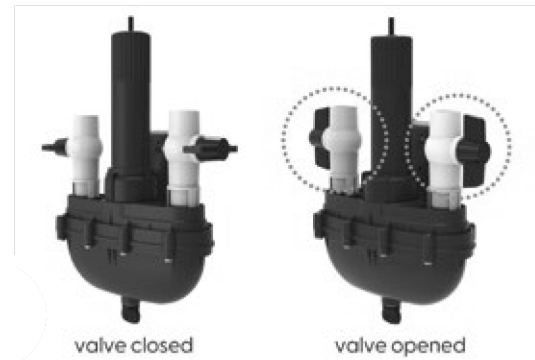

Ensure the chamber valves are open and fill the spa
Fill the spa or open the proper valve to let the water circulate in the chamber.



Plug the probe cable connector to the short cable on the CO module)



Follow further instruction on the app

Note : After startup, the readings should stabilize within 30 minutes after water circulation begins in the chamber.

Cleaning Instructions

The solution used to clean pH/ORP electrodes depends on the presence of possible contaminants. pH/ORP electrodes may show slow response due to sensor coatings or reference clogging. Use the guide below to choose the appropriate cleaning solution options:

- For general cleaning: Soak the pH/ORP electrode in 0.1 M HCl or 0.1 M HNO₃ for 20 minutes. Alternatively, an ORP electrode's platinum or gold sensor plate or band can be swabbed with an isopropyl or ethyl alcohol if convenient. Rinse well in deionized or tap water before use.
- For removal of protein deposits: Soak the pH electrode in a solution containing 1% pepsin and 0.1M HCl for 15 minutes to 1 hour depending on how dirty it may be. Rinse well in deionized or tap water before use. (NOTE: Pepsin is readily available as a powder from a lab supply house).
- If it is likely that the electrode was stored dry for an extended period and the reference junction may be dried or have the crystal formation in the pores, soaking the electrode in warm soaking/storage solution (~50 °C) may accelerate the reconditioning of the reference junction.

After any of the cleaning procedures, it is good practice to thoroughly rinse the electrode with deionized water, recondition, and recalibrate the electrode.

Test Strips

Use of Test Strips

Although Gecko waterlab provides continuous, automated water analysis, test strips remain necessary for initial calibration, periodic recalibration, and measurement of parameters not covered by the probe. Their use ensures long-term accuracy and balanced water chemistry.

Ordering Test Strips

Recommended test strips can be ordered directly through the Gecko App. This ensures compatibility with your system and supports optimal monitoring performance.

Troubleshooting minor issues

Improper conditioning may involve the glass pH sensor not being properly “hydrated”, or the reference junction not fully prepared for ion - sharing. For example, the pores of the reference junction may have dried potassium chloride crystals that need to be wetted to “recharge” the salt bridge function of the reference junction. Signs of improper conditioning may be:

- 1) Inaccuracy of a pH electrode soon after calibration
- 2) Unstable, erratic, or extremely drift readings
- 3) Lack of signal, or over- range situation if the reference junction is not working at all (meter dependent)

If it is likely that the electrode was stored dry for an extended period and the reference junction may be dried or have the crystal formation described above in the pores, soaking the electrode in warm soaking/storage solution (~50 °C) may accelerate the reconditioning of the reference junction. However, prolonged drying conditions could severely damage the glass pH sensor. After conditioning the electrode, rinse with deionized water. The electrode is ready for calibration and measurement.

Calibration

pH Electrodes

Since glass pH electrodes measure the H⁺ (hydrogen ion) concentration (or activity) relative to their reference half- cells, they must be calibrated once during its lifetime (after two years of use) to ensure accurate, repeatable measurements. It is important to use reliable pH Buffers to calibrate your pH electrode. For more information follow the steps present in the Gecko app.

6. Logistics (Things to Keep in Mind)

Storage

The pH or ORP Electrode's sensing end should never be stored dry. Always maintain moisture at the sensor and reference junction. Proper electrode storage maximizes electrode performance and extends electrode life. It is best to store electrodes in clean containers with its storage bottle filled with soaking liquid. Oftentimes a soaker bottle will have a sponge or cotton ball in the bottom – the purpose of the sponge is to maintain some solution in the event of a spill. However, it is best to store the electrode with solution present.

Do not store an electrode in deionized water - this will cause ions to leach out of the pH glass sensing bulb and the reference junction, destroying the electrode over time. Improper storage will cause the same type of issues mentioned in the troubleshooting minor issues section mentioned above.

After a few months of storage, check the condition of the probe to detect any issues. If there is mold or crystal formation, clean the probe and replace the storage solution

Handling

During shipment it is possible for air bubbles to form in the glass pH sensing bulb. The presence of such a bubble can cause a host of problems on the meter display ranging from inaccuracy to instability, to no reading at all. To remove air bubbles, shake the electrode's sensing end down in the same manner as a clinical thermometer until the bubble is dislodged and the glass sensor bulb is filled with solution. This is not an issue for ORP Electrodes. Rinse electrodes with deionized water (distilled or deionized water) before and after measuring a sample. Blot the end of the electrode with lint - free paper to remove excess water.

NOTE: Never wipe or rub the electrode to remove excess water - wiping can create static charges that interfere with correct pH measurement.

Potential failure modes and causes

Cracked glass membrane:

Reading could be all over the range or none

Slope out of range:

Inaccurate reading; when slope becomes low, pH becomes high in acid and low in base

Impedance out of range:

The pH response can become sluggish or non-stable

Biofouling:

The pH can become erratic

7. Troubleshooting

The product is consisted of a total of three LEDs representing the three main boards present within the product. The Home Transmitter board (contained within the EN Module), the Spa Transmitter board (contained within the CO Module) and the Water Monitoring board (contained within the CO module) The CO and EN module communicate together via an RF link while the Water monitoring board communicates directly to the CO transmitter board since they are both contained within the CO module. The Home Transmitter is responsible for the Ethernet communications, the Spa Transmitter is responsible for the spa communications and the Water Monitoring board is responsible for acquisition of water sampling.

Home Transmitter (EN Module) LED status

This module's LED can show various status conditions, as indicated below.

Rapidly flashing YELLOW color:

The Home Transmitter is in pairing mode when this color is shown (the pairing switch was pressed). Until a pairing successfully completes, the application cannot connect to the spa. To complete the pairing, you must turn off the spa (using its breaker), wait a few seconds and then flip back the breaker to on. The pairing will then occur within a few seconds. If not, then the Spa Transmitter is either incorrectly connected, out of range, or defective.

If the in.touch 3 modules were previously paired and the pairing switch is accidentally pressed, simply unplug the Home Transmitter USB power cord and re-plug it (thereby resetting the Home Transmitter). The modules should then normally reconnect together.

Once out of pairing mode, the Home Transmitter will display another color.

For each of the following colors, the information applies whether the LED is blinking or not. If the LED is blinking, please also refer to the Blinking LED section below.

RED color:

The Home Transmitter is not detecting a router. Until this is resolved, the application cannot connect to the spa.

Make sure the router is powered and working correctly (i.e. test it using another computer or device connected to the same LAN port you intend to use). Make sure the Ethernet cable is correctly

connected at each end (LAN port on router end, and the Home Transmitter.) If the problem still occurs, try connecting with another cable.

If a computer (or other device) works fine on the LAN port, and the cable is fine, then the home transmitter is likely defective.

GREEN color:

The Home Transmitter is connected to a router (an IP address was assigned), but the in.touch 3 server is not reachable.

This is very likely a router configuration issue, so refer to your router's User Manual. It may be due to Port 10022 being closed. Normally, this port is open by default in commercial routers, but different routers may have different behaviors.

If Port 10022 is confirmed as open, then some other internal configuration is preventing the router from accessing Internet. The server may also simply be temporarily "offline" for servicing/maintenance, so try again later. The problem can also be due to the Internet connection (WAN), a router misconfiguration, or your Internet Service Provider (ISP) has issues with its network connection.

BLUE color:

This is the normal state of the Home Transmitter LED. It has a full Internet connection, with access to the in.touch 3 server. If your device and application have access to the Internet (either via Wi-Fi or cellular data such as 3G, 4G, or LTE), then you're good to go!

Spa Transmitter (CO Module) LED status

This module's LED can show various status conditions, as shown below.

Rapidly flashing YELLOW color:

The Spa Transmitter is in pairing mode when this color is shown. This normally briefly occurs automatically during power-up of the spa (i.e. right after the breaker is flipped on). This could also occur if the Spa Transmitter was never paired (which is very unlikely, as they are shipped paired from factory). Refer to the pairing section below if your unit has not been paired, so you may complete the process.

Removing and Re-seating Pillows

You can remove the pillows for cleaning and maintenance quickly and easily. This method works for all pillow types.

Grab the lower edge of the pillow with both hands and firmly pull up, as you do this the pillow inserts will pop out of the holes.

Re-seat the pillows by aligning the pillow inserts with the holes and striking the pillow hard enough for the insert pegs to pop back in place.



Jet Removal and Replacement

Jets can be easily removed for cleaning.

Grasp the outer lip/rip of the jet and turn it counter-clockwise until it completely stops, you may feel the jet loosen and pop out a bit, pull the jet outward. The jet will be very snug and may require additional turning force to pop-out. **DO NOT PRY OUT JETS**

To replace the jet, place it in the fitting and turn clockwise until it click into place and can be rotated freely to open and close water flow again.

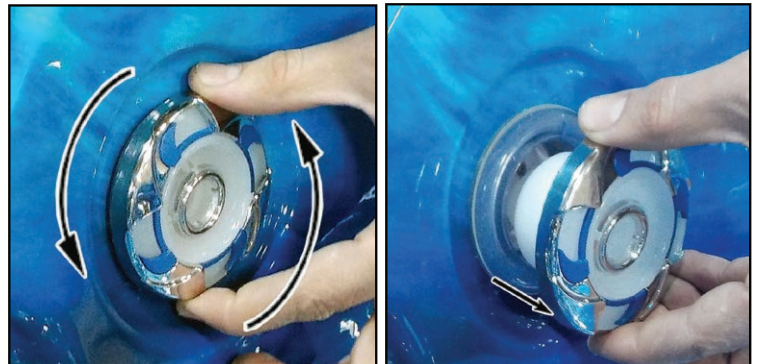

Note: have the jets turned off when removing jet inserts, it will be easier to remove when there is no water flow through it.

The spa cover can be considered one of the most important parts of your spa. The spa cover helps retain the heat inside of your spa in all different types of weather. The cover works as a lid on a thermos, when the spa is not in use the cover helps lower the amount of time the spas heater has to run for. Using the cover will help lower your operating cost of your spa when the spa is not in use.

Note: The cover is constructed of rigid foam and metal, but it is not meant to support weight for your safety, do not sit, stand, or lie on the cover, nor should you place objects on top of the spa cover

- Covered spas will protect your spas finish from the suns ultraviolet rays.
- You are required to use the spa cover to maintain warranty coverage.
- Covering your spa prevents children or pets from drowning in your spa.

Step 1 Place cover on spa. Make sure it is correctly positioned, with the skirt of the cover wrapping over your spa shell. This helps prevent blistering and cracking from sun exposure.



Step 2 Position the tie-down hardware (attached to the straps of your cover) on the side of the spa so they are easily reached by the cover tie-down straps.



Step 3 With the straps pulled tight (but not overly tight), lightly pre-drill the location for screw placement. Gently drill 3 holes - one for each screw slot in the lock.

Note: Use a low torque drill, or use the lowest setting on your drill, do not drill in the screw all the way as the corners are designed with an air pocket inside to retain heat inside of your spa. Too much force lay deform the shape of the corner and would not look as appealing.



Note: Illustrated corners may appear differently to the ones on your spa.

Step 4 Use a screwdriver to finish screwing in the three screws, repeat this process for the remaining 3 corners.



Step 5 Keep the cover fastened down at all times when not in use, locking hardware may be locked with a key (provided in the packaging of the spa cover)



Step 6 The provided key will allow you to lock down your spa cover. We recommend locking your spa cover when the spa is not in use. Store your key somewhere safe, away from children.



WARNING
AVOID
DROWNING
RISK

**FAILURE TO FOLLOW INSTRUCTIONS MAY RESULT IN INJURY OR DROWNING
NON-SECURED OR IMPROPERLY SECURED COVERS ARE A HAZARD.
REMOVE COVER COMPLETELY BEFORE ENTRY OF BATHERS.
ENTRAPMENT POSSIBLE.
KEEP COVER ON SPA AND LOCKED WHEN NOT IN USE**

Cover & Locking System for Escape X Spas

The spa cover can be considered one of the most important parts of your spa. The spa cover helps retain the heat inside of your spa in all different types of weather. The cover works as a lid on a thermos, when the spa is not in use the cover helps lower the amount of time, the spas heater has to run for. Using the cover will help lower your operating cost of your spa when the spa is not in use.

Note: The cover is constructed of rigid foam and metal, but it is not meant to support weight for your safety, do not sit, stand, or lie on the cover, nor should you place objects on top of the spa cover

- Covered spas will protect your spas finish from the suns ultraviolet rays.
- You are required to use the spa cover to maintain warranty coverage.
- Covering your spa prevents children or pets from drowning in your spa.

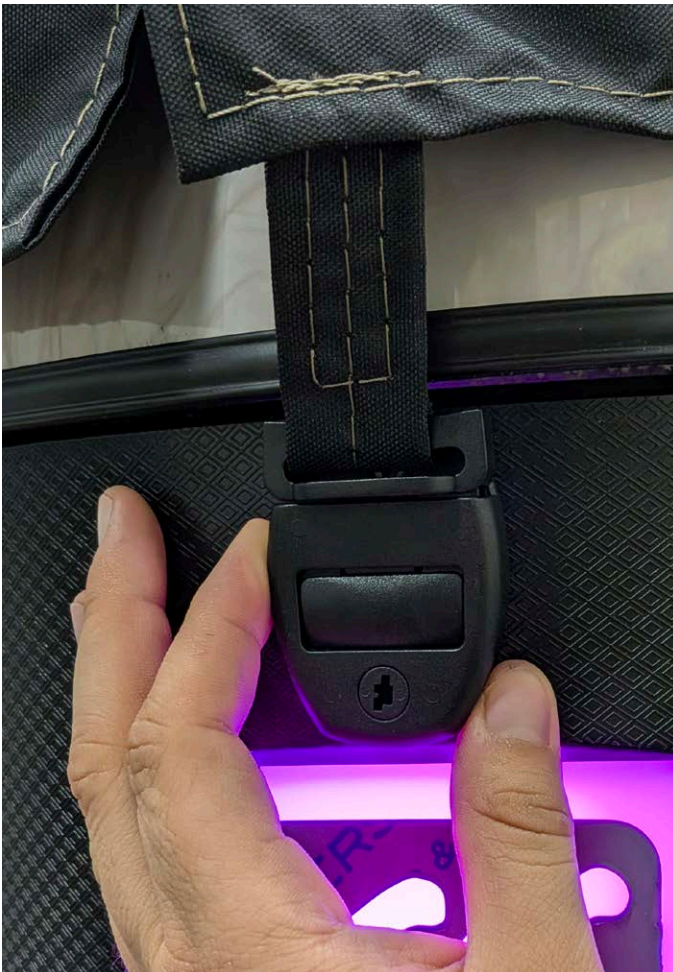

Step One

Note: Clearance for the locking mechanism is minimal to keep the visual styling of the corners. Following this installation procedure should not cause thermal issues or safety issues.

Align the spa cover with the corners of the spa. Depending on the spa cover the fabric strap may attach at an angle, this is considered normal as it provides tension around the curved acrylic.



Step Two

After aligning the spa cover remove the base of the locking mechanism from the ends of the cover. Make sure to obtain and collect all your spa cover lock hardware including screws, which are within a small envelopes inside of your spa cover packaging.

Step Three

Use the non-marking tape to hold the base of the lock onto the top of the spa corner. The base of the locking mechanism should sit almost perfectly in the gap from the top of the light to the top edge of the corner.

You may also freehand the installation of the base but it is not advised due to the risk of installing the base improperly, avoiding extra work correcting the issue.

Ensure that the base of the locking mechanism is centered in the middle axis of the corner.

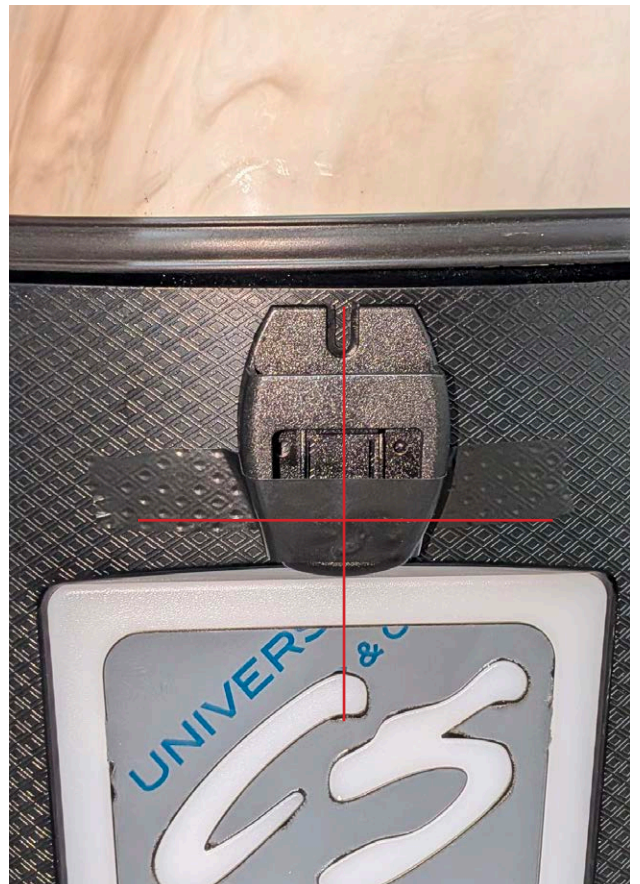



Step Four

Use the 3/32nd drill bit to tap into the two holes inside of the base. Use minimal force when performing the tap onto the spa corner.



Step Five

After tapping the corner, use a small hand screwdriver to screw in the small screws within the lock hardware. Ideally you can lightly insert both screws to assist in keeping the base of the lock secured and level.

Do not use power tools to perform the installation of the screws. The use of power tools to install the screws increases the risk of breaking or snapping the screw or the corner panel itself.



Step Six

After this is done you may remove the tape used to keep the base in place. You can now click in the male end of the spa cover to the base.

Note: *The covers male adapter, is inserted at a slight angle downwards due to the lip of the spa.*

If the spa will not be used after installation, click the lock into place and use the provided plastic keys to lock it.

To unlock, use the provided key to place in the unlock position and press the button to release.

Your spa should be drained every four to six months for cleaning and maintenance and refilled with fresh tap water. Before you begin turn the power off to the spa at the breaker and remove your filters.

Step 1. Locate Your Drain

Pull the knob out of the cabinet. The cabinet drain is screwed into the drain pull knob.



Step 2. Remove the cap

Make sure the valve is in the closed position, then unscrew and remove the cap.



Step 3. Connect Valve to a Hose

Attach a garden hose to the hose-bib fixture. Place the other end of the garden hose where you would like the water to drain to.

Step 4. Drain the Spa

Turn the valve on the hose-bib fixture to open the drain. When the spa has drained completely, turn the valve on the hose-bib fixture, remove the hose and replace the cap.

Winterizing (Cold Climate Draining)

Depending on your region in your country, the temperature could drop below 32F(0°C). If you are one of those regions, we recommend that you always have your spa full of water and running at normal spa temperatures between 80°F - 100°F (26.7°C - 37.8°C). This will help reduce the risk of water freezing in your spa and inside of the spa equipment.

WARNING: If you find the need to drain your spa, be aware of the potential risk of water freezing in your spas equipment and plumbing, even if the directions below are followed perfectly, there is no guarantee that your spa will not suffer freeze damage. Freeze damage is not covered under warranty.

- 1 - Open all filter covers.
- 2 - Remove the filter baskets and filters
- 3 - Drain your spa completely.
- 4 - Vacuum water from the spa's main drain fitting with a wet/dry vacuum
- 5 - Open the bleeder valves on the pumps
- 6 - For spas equipped with a UV light, loosen the quarts tube nut to let the water drain from the UV light chamber.
- 7 - Disconnect the unions from both sides of the pump.
- 8 - Blow out any remaining water out of the jets, suctions, filter canister, and equipment area with a wet/dry shop vac.
- 9 - When it has completely finished draining, replace the quarts tube in the UV lamp chamber, and tighten the nut. Close the bleeder valves and re-connect the unions on the pumps.
- 10 - Replace the filter basket and filters.
- 11 - Cover your spa with a good spa cover and an all weather tarp to ensure neither rain nor snow enters the spa.



Note: Do not use antifreeze to treat your spa, this is a health hazard and can cause irreversible damage will to the spa.

Cleaning and Replacing the Filter

Filtration is one of the most important steps you can take to ensure clean, clear water. It is far less expensive to fix water clarity problems by properly filtering your spa than using excessive amounts of chemicals, excessive filtration times, or by water replacement.

Vacation Care

You can leave your spa locked and unattended for up to two weeks if you follow these instructions

Note: Always lock your spa cover using the cover locks if you plan to be away from home and the spa is filled with water, these instructions will help maintain your water quality for up to two weeks. Use of the spa during this period of time by guests or family can affect the clarity and conditions of the spa.

Select a low range temperature of 80F (27C)

Note: Platinum Spas & Escape Spas with Gecko systems, Refer to filtration mode "Away From Home"

1. Use a test strip, Adjust pH, AK, and CH if necessary.
2. Shock the spa water with your selected sanitizer (Add either bromine or chlorine)
3. Lock the spa cover to the cover locks.
4. When you return, test the water again and adjust pH and shock the water again.

If you will not be using your spa for longer than 14 days and the spa is not able to be maintained, we recommend following the cold climate procedure to prevent algae growth, bacteria, and spa damage.

Spa Cover and Pillows

Due to constant punishment your spa cover and pillow receive, you should protect them by applying a vinyl and leather cleaner as part of your monthly maintenance plan. Use a product that is designed specific to spa covers and pillows, to protect them from UV ray damage without leaving an oily residue. Contact your spa dealer for recommendations.

Warning DO NOT use any kind of automotive vinyl protectants on spa pillows or covers (ex. Armor all, Meguiar's, etc). These products are oil based and will leave an oily layer on your water line and will cause severe water clarity issues that require hours of work to correct, including multiple flushes of the system.

Spa Shell

Each time the spa is drained, before the spa is refilled it should be cleaned with an all purpose cleaner, or a mild detergent, followed up with a surface protectant. Do not use abrasive chemicals or cleaning tools as it may scratch the acrylic. Use a non oil based protectant designed for spas to protect the finish from mineral build up associated with normal spa use.

Using the Freedom Sound System

The Freedom Sound System™ entertainment option contains a Bluetooth enabled speaker system that is available for certain Cal Spa models. Any Bluetooth- enabled device can be used to play audio through your spa. Before you can use the sound system, you will need to pair the speakers to your smart device via Bluetooth. The Freedom Sound System will respond to equalizer (EQ) from your mobile device, use your devices settings to adjust bass, treble, or certain frequencies you wish to amplify.

On your mobile device, open the settings and select Bluetooth, the device will begin to scan for available devices. Bluetooth signal is the strongest when you are next to the spa with a range of 5-10 feet based on conditions and the position of the spa.

The sound system will appear as "Aquatic AV" on your mobile device. Apple devices may require a password to pair , use "0000" to pair the spa to your device. Android devices will pair at initial selection from your devices Bluetooth menu.

Once your device is paired and connected, all sounds from your device will be played through the sound system, including system sounds and telephone.

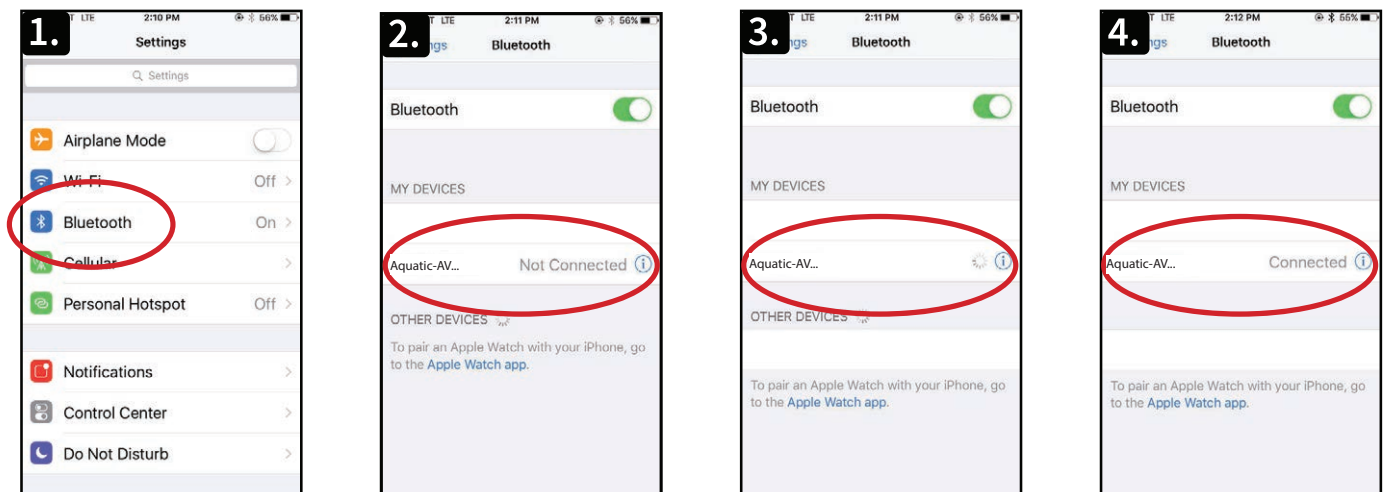

Buying replacement filters, parts, or accessories is part of spa ownership, but finding commonly replaced or ordered parts for your spa model is made easy, and just a few clicks away. Using your spa serial number, you may look up and find your exact spa model and find these components.

Website: WWW.QUICKSPAPARTS.COM

***Note: Images in this guide are for example purposes, no deals or offers shown in these images are accurate. Always check our website for promotions or exclusive offers/discounts*

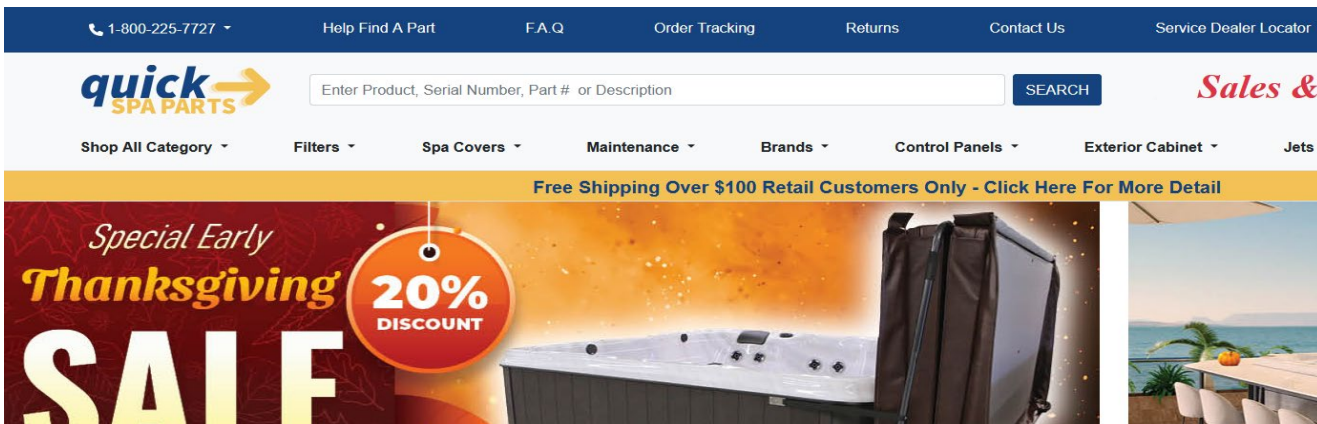

Quickspaparts is our factory parts website, where you can get multiple components for your spa, including common universal components. We intend for our spas to last you for many years to come, therefore we want to ensure the process of ordering common parts, is as easy as it can get.

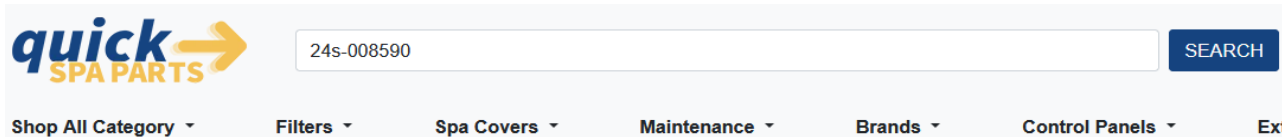

Using your spas serial number (located in the front cabinet, on the bottom right), type this serial number in the quick spa parts search bar to find general components for your spa.

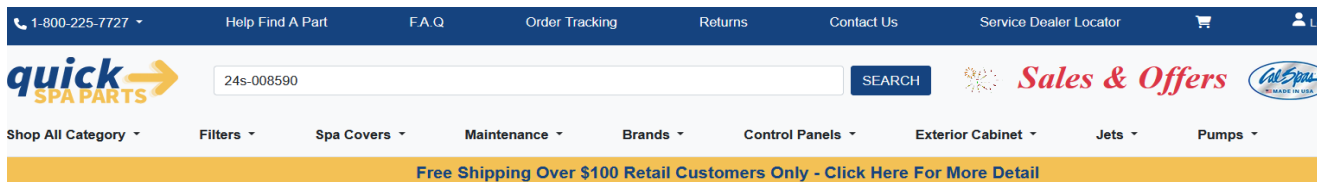

Search Results for Serial Number 24S-008590

Model# **L-S24-EC867L-24**
 Serial# **24S-008590**
 2024 EC-867L-24 67 JETS,
 LOUNGER, ESCAPE
 SPAS

- Accessories (1)
- Cabinet (5)
- Circuit Boards (1)
- Control Boxes (1)
- Control Panels (2)
- Covers (1)
- Electrical (0)
- Entertainment (2)
- Filter Parts (3)
- Filters (0)
- Heaters (1)
- Jets (17)
- Lights (7)
- Parts (1)
- Pillows (1)
- Plumbing (43)
- Pumps (3)

Using your serial number will bring up common components that most spa owners would search for when replacing components. Not all components will appear in the search results, if that is the case reach out to your spa dealer for ordering certain components.

Note: If you dealer is no longer in service, or you have inherited or purchased a used spa. You can contact us directly at customerservice@calspas.com with your spa serial number and an image of the needed component.

<p>1 to 3 ext cord</p> <p>LIT16100335</p>	
<p>1 to 1 port ext cord</p> <p>LIT16100338</p>	
<p>Interior Light with Logic (7 LEDs)</p> <p>LIT16100337</p>	
<p>Interior Light without Logic (7 LEDs)</p> <p>LIT16100333</p>	
<p>Main Light Housing (LED Lens, grommet/gasket)</p> <p>LIT630-7048</p>	
<p>Filter Cartridge 75 sqft</p> <p>FIL517-4619LC-DSG</p>	
<p>Filter Cartridge 50 sqft</p> <p>FIL50-%D13H15FCT-3</p>	

<p>SGMS Teleweir Filter, 50 Sq. Ft. 6 Scallop, w/out Cartridge, 2" Check Valve, HLG (517-4609LC-HLG)</p> <p>FIL517-4609LC-HLG</p>	<p>FILTER UP-ANCHOR SKIMMER WHITE (Pantone PMS 2330C) (L-2124)</p> <p>FIL11700330</p>
<p>SGMS Ultra Skim Filter, 75 Sq. Ft. w/out Weir, with Cartridge, HLG (517-4619LC-HLG)</p> <p>FIL517-4619LC-HLG</p>	<p>3 Inch Jet Insert (3DR) Mini Storm Internal, Twister, Vector X Style HLG</p> <p>PLUCS2441049S-HLG</p>
<p>FILTER PLATE WHITE WITH CAL SPA LOGO EVA (L-4235)</p> <p>FIL11700331</p>	
<p>FILTER CARTRIDGE 50 SQFT,</p> <p>FIL11700338</p>	
<p>5 Inch Jet Insert Power Storm Internal, Roto, HLG Vector X Style, Metal, With O-Ring on Diffuser</p> <p>PLUCS2247049S-HLG</p>	
<p>5 inch Jet Insert - (5T) Adjustable Whirlpool Internal, Vector X Style, Metal</p> <p>PLUCS2394029S-HLG</p>	
<p>Cal Spas Cascade Pillow (Off White)</p> <p>ACC01401103-W</p>	

<p>2 Inch Jet Insert (2D) Cluster Storm Internal, Directional, Vector X Style, Assy</p> <p>PLUCS2440019S-HLG</p>	
<p>5 inch Jet Insert - (5T) Adjustable Whirlpool Internal, Vector X Style, Metal</p> <p>PLUCS2440029S-HLG</p>	
<p>3 Inch Jet Insert (3D) Mini Storm Internal, Multi-Massage, Vector X Style, Metal, With O-Ring on Diffuser</p> <p>PLUCS2445059S-HLG</p>	
<p>3 Inch Jet Insert (3D) Mini Storm Directional Metal Eyeball Int. Vector X Style Assy</p> <p>PLUCS2445009SSH LG</p>	
<p>4.5 Inch Poly Storm Internal, Metal Directional E/B, Vector X Style, Metal, With O-Ring on Diffuser HLG</p> <p>PLUCS2446009SSH LG</p>	
<p>4.5 Inch Jet Insert Poly Storm Internal, Metal Roto E/B - HLG Vector X Style, Metal, With O-Ring on Diffuser</p> <p>PLUCS2446029SSH LG</p>	
<p>Cal Spas Y- Pillow (Off White)</p> <p>ACC01401102-W</p>	

<p>4.5 inch Jet Insert Poly Storm Internal, Waterway Roto E/B - HLG Vector X Style, Metal, With O-Ring on Diffuser</p> <p>PLUCS2446039SHLG</p>	
<p>4.5 Inch Jet Insert Poly Storm Internal, Turbine, HLG Vector X Style, Metal, With O-Ring on Diffuser</p> <p>PLUCS2446069S-HLG</p>	
<p>5 Inch Jet Insert (5D) Power Storm Internal, Metal Directional E/B - HLG Vector X Style, Metal, With O-Ring on Diffuser</p> <p>PLUCS2447009SSH LG</p>	
<p>5 Inch Power Storm Internal, Tri Directional E/B - HLG Vector X Style, Metal, With O-Ring on Diffuser</p> <p>PLUCS2447019SHLG</p>	
<p>5 Inch Jet Insert Power Storm Internal, Metal Twin Roto E/B, HLG Vector X Style, Metal, With O-Ring on Diffuser</p> <p>PLUCS2447049SSH LG</p>	
<p>5 Inch Jet Insert Power Storm Internal, Turbine, HLG Vector X Style, Metal, With O-Ring on Diffuser</p> <p>PLUCS2447069S-HLG</p>	
<p>Waterfall LED Spillway 12"</p> <p>PLU21801038</p>	

<p>1 LED Light String LIT16100330</p>	 A single white LED light string with a coiled cable and a power connector.
<p>2 LED Light String LIT16100331</p>	 A white LED light string with a coiled cable and two power connectors.
<p>4 LED Light String LIT16100332</p>	 A white LED light string with a coiled cable and four power connectors.
<p>Spa Cover Locks and Keys ACC01800026, ACC01800020</p>	 Four black spa cover locks arranged in a 2x2 grid, with two keys placed between them.
<p>Waterfall LED Spillway, 18" Large PLU21801039</p>	 A long, rectangular white spillway with a central circular opening, accompanied by a blue connector and a small grey cap.

Replacement of Cabinet Panels

The complete selection of replacement cabinets for all models is very extensive and too lengthy for this owner's manual. To order replacement panels for your spa, visit www.quickspaparts.com

Covers

All spa covers are designed with a tapered height, angling downward from the center to the sides to drive off rain and prevent water from pooling. The covers listed below are filled with either 1 lb., 15. lbs., or 2.0 lbs. foam.

Basic

4" - 2.5"

1.5 lbs. foam



Deluxe

5" - 3"

2.0 lbs. foam



84" x 84" (7 foot spas)

Fits spa models: PL-760L, PL760B, PPL7B

	Basic	Standard
Black	COV848BBK-3	COV8484SBK-3
Grey	COV8484BG-3	COV8484SG-3
Brown	COV8484BDB-3	COV8484SDB-3

93" x 93" (8 foot spas)

Fits spa models: PL-860L, PL-861B, PL880L, PL-881B, PPL8B

	Basic	Standard	Deluxe
Black	COV9393BBK-3	COV9393SBK-3	COV9393DBK-3
Grey	COV9393BG-3	COV9393SG-3	COV9393DG-3
Brown	COV9393BDB-3	COV9393SDB-3	COV9393DDB-3

Basic Troubleshooting

The troubleshooting guidance provided here is intended to cover the most common problems a spa owner may encounter. For more in-depth troubleshooting, go to www.calspas.com/troubleshooting.

Symptom	Possible Solutions
---------	--------------------

Problems starting up

Pump won't prime	See priming instructions Pg 12
Breaker keeps shutting off	Reset the GFCI breaker. If this continues, contact your dealer or a qualified spa technician.

Power and system problems

System won't start up or breaker keeps shutting off	Power may be shut off. Turn on GFCI circuit breaker. If this continues, contact your dealer or a qualified spa technician.
Control panel doesn't respond	Turn on or reset the GFCI circuit breaker. If this does not solve the problem, contact your dealer or a qualified spa technician. If you hear the pump running but the control panel doesn't respond, contact your dealer
Spa does not turn off	Spa may be trying to heat up. Check if spa is in Ready or Rest mode In cold climates, if spa is not equipped with full foam or any kind of insulation, it will try to maintain the set temperature. Set the spa to low temperature range and set the temperature to 80°F. Spa may be in filter cycle. If it is, this is normal and no adjustment is necessary.
Message on the control panel	There may be a problem. See Diagnostic Messages

Heat problems

Spa water does not get hot	Spa may be in low temperature range. Set the spa to high temperature range. The filter may be dirty or may need to be replaced. Clean or replace the filter. The water level may be too low. Fill the spa with water level at 4 to 6 inches from the top. The temperature is not turned up high enough. Raise temperature on topside control. Cover the spa. The cover will keep heat in the spa and help keep heat from escaping. Make sure cover is on at all times when spa is not in use. The heater element may be old, deteriorated, coated with scale, or defective. Contact your dealer for more assistance. The gate valves may be partially or completely closed. NEVER OPERATE YOUR SPA WITH THE GATE VALVES CLOSED!
----------------------------	---

Symptom	Possible Solutions
Spa overheats - temperature greater than 110°F / 43°C	<p>Overheating can occur during summer months and may not necessarily indicate a malfunction. When it occurs, a message code may also appear on the control panel.</p> <p>Temperature may be set too high. Turn the set temperature down to a lower temperature.</p> <p>Filtration time may be too long. Turn the filtration cycles down during the warm months.</p> <p>The spa may not be properly ventilated. Make sure the front of the spa is not blocked to allow air flow.</p> <p>High speed pumps may have been running too long. Limit pump running time to no more than 15 to 30 minutes.</p>

Water pressure problems

Low water pressure	<p>Jet valves may be partially or fully closed. Open the jet valves.</p> <p>Filter cartridge may be dirty. Clean or replace the filter.</p> <p>Pump may have airlock. Remove airlock by priming spa</p> <p>The suction fittings may be blocked. Remove any debris that may be blocking them.</p> <p>The filter skimmer may be blocked. Remove the blockage.</p> <p>Gate valves may be closed. Open gate valves. Note: Never operate your spa with the gate valves closed!</p> <p>Spa may be running in filtration mode. Press JETS or JETS 1 button to turn on high speed pump.</p>
No water pressure (no water stream from any jets)	<p>Power may be switched off. Turn the power back on.</p> <p>The pump may be defective. After you have tried all other troubleshooting, contact your dealer for assistance.</p>
Jets surge on and off	Water level may be too low. Add water to normal level.

Pump problems

Pump runs constantly – will not shut off	There may be a problem with circuit board. Contact your dealer.
Noisy pump	<p>The water level may be too low. Fill the spa with water level at 4 to 6 inches from the top.</p> <p>Filter cartridge may be dirty. Clean or replace the filter.</p> <p>Pump may have airlock. Remove airlock by priming spa</p> <p>The suction fittings may be blocked. Remove any debris that may be blocking the suction fittings.</p> <p>Gate valves may be closed. Open gate valves. Note: Never operate your spa with the gate valves closed!</p> <p>Air may be leaking into the suction line. Contact your dealer for assistance.</p> <p>Debris may be inside the pump. Contact your dealer for assistance.</p> <p>Noise may be a sign of damage. Contact your dealer for service.</p>

Symptom	Possible Solutions
Pump turns off during operation	Automatic timer may have completed its cycle. Press JETS or JETS 1 button to start the cycle again. Pump may have overheated due to the vents on the equipment door being blocked. Make sure the front of the spa is not blocked to allow air flow. The pump motor may be defective. Contact your dealer for assistance.
Pump has a burning smell while running	A burning smell may be a sign of damage. Contact your dealer for service.
Pump does not run	Pump may have over heated. Let it cool for an hour and try operating the spa for a shorter time. Power to the spa may be shut off. Turn on or reset the GFCI circuit breaker. If this does not solve the problem, contact your dealer or a qualified spa technician.

“Thermal Creep”

Cal Spas are designed with energy-efficient components and systems that are meant to sustain heat generated by the equipment, which is then cycled back into the spa water. In hot weather or in situations where the spa is set to extended run times, Thermal Creep may occur. Thermal Creep is a condition where the measured water temperature can be higher than the set temperature. To manage Thermal Creep you may:

Vent your cover. This means placing a folded cloth about ¾” (2cm) thick under all four corners of the cover before you lock the cover down.

Open your cover. Opening the cover at night will also quickly cool the water down if desired.

Open all air controls. Set your filtration cycles to run during the cooler times of the day or night.

Reduce the length of your filter cycles.

Visit your local dealer for additional guidance.

Since Thermal Creep only occurs in well-insulated hot tubs, it is not indicative of something that is wrong with your spa or its equipment.



LIMITED WARRANTY

This Limited Warranty is extended to the original purchaser of the spa produced by Lloyd’s Material Supply company, Inc. Which Manufactures the Cal Spas brand portable spa manufactured after January 1st, 2026 and installed for residential use in the United States of America and Canada. This Warranty begins on the date of delivery of the spa, but in no event later than one year from the date of manufacture.

Platinum & Escape

Structural	Warrantied against spa shell collapse, leaks caused by the shell, or dangers of structural integrity due to defects in the spa shell.	10 Years
Shell Surface	Warrantied against spontaneous blistering, cracking, or delaminating of the interior spa shell.	7 Years
Equipment & Controls	Electrical Equipment- limited to spa pumps, standard heater, and control system/panels, are warrantied against malfunction due to defects in workmanship or materials.	5 Years
Plumbing	Warrantied against leaks/cracks due to defects in workmanship or materials	5 Years
Spa Cabinet	Warrantied against defects in workmanship or materials. Normal wear and weathering of the finish will occur naturally over time and are not defects.	5 Years
Sanitation	Salt cells & bromine generators are warrantied against defects in workmanship or materials, this includes sanitation control panels & electrical.	1 Year
Ozone/UV	Ozone Generators and UV treatment systems are warrantied against defects in workmanship and materials. (Excluding UV bulbs older than one year)	2 Years
LED Lighting	LED lights are warrantied against malfunction due to defects in workmanship and materials	2 Years
Sound System	The Freedom Sound System is warrantied against malfunction due to defects in workmanship and materials. This does not cover normal wear and tear.	1 Year
Spa Cover	The spa cover is warrantied against malfunction due to defects in workmanship and materials. This does not cover normal wear and tear.	3 Years

Warranty for Other Components

The fuses, headrests, cal grip, labels, and filters are warrantied to be free of defects in workmanship and material at the time of delivery. All other factory-installed components not mentioned specifically, including, but not limited to the wood frame, jets, diverter valves, filter lids, and other mechanical components, are warrantied against malfunction due to defects in workmanship and material for two years from the original date of delivery. This warranty is void if the spa has endured neglect, chemical abuse, or use of unapproved chemicals or components.

Structural

This limited warranty covers defects within the spas fiberglass structural shell. This includes sudden spa shell collapse, leaking through the shell, and separation between the spa shell and spa acrylic, caused by faulty bonding. This does not include separation due to micro-abrasions, pin holes in the shell, or warping/bubbling due to sun exposure. This limited warranty does not apply when abuse of the spa shell is evident. This includes but is not limited too, heavy impact craters, fractures on the spa surface due to poor spa care, sun exposure, or reckless use of the spa, and chemical abuse of the spa. This warranty does not cover damage caused by unlevelled ground. Spas must rest on level ground, ideally on a cement slab of 3-6" of thickness depending on the spa weight. Spas that are not placed on a leveled foundation are prone to cracks, delamination, and compromised structural rigidity of the spa. It is the responsibility of the spa owner to ensure that the spas foundation is leveled and inspected before placing the spa.

Shell Surface

This limited warranty covers defects on the spas acrylic surface due to workmanship or materials. This covers wrinkles on the acrylic, blistering, peeling, delamination, or spontaneous cracking. This warranty does not cover shell damage caused by chemical abuse, improper water chemistry, excessive sun exposure, micro-abrasions, or damage caused by impacts or sharp objects. This warranty does not cover discoloration, or deterioration of the spa shell when exposed to improper chemistry levels, hard water, soft water, or chemical abuse.

Equipment and Controls

This limited warranty covers malfunction of factory installed spa control systems, spa control panels, spa heater, and spa pumps due to defects in workmanship or materials. This covers sudden control box failure, malfunction of control panels or control boxes, malfunctioning heaters, and malfunctioning spa pumps. This warranty coverage is void if the electrical installation of the spa does not follow the outlined diagrams and specifications, mentioned in this manual. Failure to properly follow the specified GFCI requirements, wire type, wire thickness, compliance with NEC guidelines and local codes will void your warranty. This warranty does not cover acts of god or nature that can damage spa equipment, such examples are flooding, lightning strikes, wildfires, or other scenarios out of the control of the manufacturer.

Plumbing

This limited warranty covers leaking of water through plumbing joints, tees, hoses, water features, and jet body grommets due to defects in workmanship and materials. This warranty does not cover damage caused by chemical abuse, improper water chemistry, or use of unapproved chemicals/sanitizers. This warranty does not cover freeze damage caused by frozen water expanding within the plumbing of the spa. The winterization procedure within this manual does not guarantee freeze damage prevention. The best method to ensure the spa does not encounter frozen water within the plumbing is to have the spa operating during the colder months of the year. This warranty does not cover freeze damage or damage to the plumbing due to acts of god and/or nature including but not limited too snowstorms, blizzards, power outages, etc. This warranty does not cover oxidation or warping of jets due to chemical abuse or exposing an empty spa to the elements with no secured cover.

Spa Cabinet

This limited warranty covers defects in workmanship and materials of spa cabinet panels. This warranty applies for warping of spa panels, cracking of corners and panels without clear impact markers, and buckling of spa panels. This warranty does not cover natural wear and tear, which occurs with plastics exposed to the sun. This warranty does not cover panel damage from excessive heat sources, calcium/water-spot build up from sprinklers or irrigation systems, or impact damage. Each claim for spa cabinets are evaluated on a case by case basis, it is the responsibility of the spa owner to acknowledge environmental factors, that can affect the maintenance of the spas cabinet panels. Using plastic spa protectants can prolong the life of your spa panels is highly recommended in high UV index climates. Deterioration/fading of color, natural wear and tear of plastic materials is expected over time, and is not considered a defect in materials. This coverage does not extend nor cover acts of god or nature that can damage spa panels, such examples are flooding, high winds, wildfires, tornadoes or other scenarios out of the control of the manufacturer

Sanitation

This limited warranty covers malfunctions of factory installed Salt Systems and Bromine generators, which are warranted against malfunction due to defects in workmanship or materials. This includes the salt cell, sanitizer control panels, bromine generator, and power supplies for Cal Salt systems. This warranty does not cover negligent operation of sanitizer systems, chemical abuse, damage caused by improper water chemistry, or disregard of specified data points for safe operation; including but not limited to, incorrect ppm levels of salts, excess operating hours of the Cal Salt cell, or improper maintenance of sanitation components. The spa filter is not a part of this warranty, and is considered a disposable item subject to regular wear and tear.

Ozone/UV Systems

This limited warranty covers malfunctions of factory installed Ozone and/or UV water treatment systems. This includes leaks through welded components, water back-flow into the ozone generator, and short circuited Ozone or UV systems. This warranty does not cover UV bulbs that are older than 10 months, the UV light must be replaced every 10-12 months as this is normal wear and tear of component. This warranty is voided if alterations/modifications of these systems are evident, or if the spa electrical connections were not installed in accordance to defined specifications within this manual, evidence of chemical abuse, and acts of god and/or nature.

Sound System

This limited warranty covers malfunctions of factory installed sound system components. This includes the sub-woofer/amplifier, speakers, speaker grills, power supply, or Bluetooth antenna. Natural wear and tear of speaker cones is not covered by this warranty, nor are deterioration of speakers exposed to chemical abuse.

Spa Cover

The spa cover is warranted against defects of materials and workmanship for the defined period mentioned in this warranty. Exposure to UV rays on untreated or poorly maintained spa covers are not covered by this warranty. It is the responsibility of the spa owner to use spa UV plastic protectants on their spa covers, especially in high UV index climates. Exposure to UV light without proper treatment leads to problems such as cracking/peeling of vinyl covers, and sudden fading of color. This warranty does not warrant against damage caused by chemical abuse, nor yellowing or oxidation of the spa cover when exposed to excess sanitizer. If a defect is found within the first 90 days of ownership, your Cal Spas dealer and Cal Spas can directly assist the spa owner filing a claim and replacing the spa cover if deemed necessary. Spa owners with spa covers past the 90 day period that are discovered to have a defect, can contact your Cal Spa dealer to begin the process of filing a claim. When filing a claim of a spa cover than is older than 90 days, this warranty will cover the material cost of issuing a new vinyl sleeve for the cover, and/or replacement foam for your cover. Shipping/freight costs are not covered in this warranty, and are the sole responsibility of the spa owner. Images of the cover from all sides including the top and underside are necessary to file a claim.

Genuine Cal Spas Parts & Accessories

This Limited Warranty is void if Lloyd's Material Supply Company, Inc., Manufacturer of the Cal Spas brand or its designated representative determines that the spa has been subjected to damage or failure due to installation of aftermarket parts that are not genuine Cal Spas branded parts and accessories. This disclaimer includes, but is not limited to filters, UV bulbs, ozone systems, salt systems, replacement parts and other accessories. Genuine Cal Spas brand parts and accessories are built to our highest standards of quality, durability and performance, and they are designed to work with your spa to ensure optimal performance and function. Only parts/components approved by Cal Spas should used when performing a warranty repair. If parts are required to complete a warranty claim, the cost of the parts are covered by this warranty. Approved labor and genuine part costs are covered when a warranty claim is approved, the cost of shipping parts/components is not covered by this warranty, and its the sole responsibility of the spa owner.

Performance

This warranty begins on the date of delivery of the spa, but in no event later than one year from the date of manufacture. To obtain service in the event of a defect covered by this Limited Warranty, notify your Cal Spas dealer or Cal spas as soon as possible and use all reasonable means to protect the spa from further damage. Upon proof of purchase, a designated service representative will correct the defect subject to the terms and conditions contained in this Limited Warranty. There will be no charge for parts or Labor to repair the defect, although providing access to affect the repair is your responsibility as the spa owner. Freight charges for replacement parts is the responsibility of the spa owner. Parts and components can be shipped to the servicing dealer or to the customer. The servicing dealer may charge the owner a travel/service fee as well as a diagnose fee if the cause of the issue is unknown, these charges are not covered under warranty. Your spa dealer nor Cal Spas is responsible for damages or costs to rebuild decks, cement structures, or other decor/structures placed against the sides of the spa. Minimum clearance of 3 feet on each side is mandatory for all spas. In the event that the spa is removed to a repair facility for repair and reinstalled, the cost of removal and re-installation will be your responsibility as the spa owner. If Lloyd's Material Supply Company Inc., The manufacture of the Cal Spa brand determines that repair of the covered defect is not feasible, it reserves the right to provide a replacement spa of equal or lesser value to the original purchase price. In such an event reasonable costs for removal of the original spa, shipping costs from the factory for the replacement spa, and delivery and installation of the replacement spa will be the responsibility of the spa owner. The replacement spa will carry the balance of the original spa's warranty. Spa covers are not included. This warranty ends either by specified time frame, owner-transfer of the spa, relocation, or installation of any component other than by the manufacture. If the desired spa is more expensive than what the spa owner originally financed or paid for, the price difference shall be paid by the spa owner. Additional costs can be incurred if the use of heavy machinery such as a crane, bulldozer, etc, is considered necessary to access, remove, or perform a repair/correction to the affected spa.

Warranty limitations

This Limited Warranty is void if Cal Spas or its designated representative determines that the spa has been subjected to alteration, neglect, misuse or abuse, or freight damage caused by the common carrier; any repairs have been attempted by anyone other than a designated representative; or if the failure is caused by accident, acts of God or other causes beyond the control of the Manufacturer including acts of nature (damage caused by animals, rodents, or other pests) are not covered by this warranty. Additionally; the limited warranty is void for spas that were subject to neglect, misuse and abuse including any installation, operation or maintenance of the spa other than in accordance with the instructions contained in the owner's manual provided with the spa, including but not limited to the failure to maintain proper water chemistry, chemical balancing, the use of abrasives or improper cleaners, and the use of non-genuine parts and accessories. This Limited Warranty does not provide coverage for any item attached to or installed on the spa after the date of manufacture or for gaining access to any component for repair or replacement. Spa units in commercial use are excluded from any coverage whatsoever. The spa owner accepts liability for repair work performed by anyone other than Lloyd's Material Supply Company Inc, or a designated Cal Spas representative. This Limited Warranty is void if damage occurs to the spa shell because of excessive heat buildup due to failure to cover a spa that is empty of water while exposed to direct sunlight.

Proration of Warranty

Units determined by the manufacture to be non-repairable will be replaced on a prorated basis with the same or a comparable unit. The owner will be charged 1% of the current retail cost for each full month of ownership from the date of purchase through the date failure is determined to be non-repairable. This charge will be waived during the first 6 months of ownership. [example]: Product failure is determined during seven months of ownership. Owner will be responsible to pay for 7% of the products current cost. As the spa owner you have the choice to replace the spa, with a spa equal to or less than the value of the originally financed/purchased spa; if the desired replacement spa is of a higher cost than the originally financed/purchased spa, the spa owner will pay the difference of price, including any percent value lost over time through the spas proration period. The cost of shipping a new spa and its installation is not covered by this warranty as stated in the "Performance" section of this warranty.

Limitations

The manufacture disclaims all warranties, expressed or implies, in fact or in law, to the extent allowed by your State's law, including the warranty of merchantability and fitness for use, except as stated specifically herein. All warranty service must be performed by the manufacture or its designated representative using authorized Cal Spas parts. No agent, dealer, distributor, service company, or other party is authorized to change, modify, or extend the terms of this limited warranty in any manner whatsoever. The manufacture will not be responsible for any statements or representations made in any form that go beyond, are broader than, or are inconsistent with any authorized literature or specifications furnished by Cal Spas. Extended warranties or care plans offered to you by a spa dealer is an agreement strictly between the spa owner and the spa dealer, out of the control of the manufacture of Cal Spas.

Disclaimers

Lloyd's Material Supply Company, Inc., Manufacture of Cal Spas brand and its representatives shall not be liable for any injury, loss, cost, or other damage whether incidental or consequential, arising out of any defect covered by this limited warranty, including without limitation, loss of use of the spa and cost for removal of defective produce even if the manufacture was advised of the possibility of damage. The liability of the manufacture under this limited warranty, if any shall not exceed the original amount paid for the defective product. Coverage under this limited warranty shall commence as of the original date of delivery and the duration of such coverage shall not extend for any reason whatsoever beyond the stated time periods. These disclaimers shall be equally applicable to any service provided by the manufacture and its designated representatives.

Legal Rights

This limited warranty gives you specific legal rights. You may also have other rights that vary from state to state depending on consumer regulations. Some states do not allow limitations on how long an implied warranty lasts, so this time limitation may not apply to you.

Chemical Abuse

Chemical abuse is defined as improper use of approved spa chemicals, and the usage of unapproved chemicals, including but not limited to sanitizers, water chemistry adjustment chemicals, water clarifier's, etc. Abuse of chemicals can cause damage to the spas finish, acrylic shell, jet body seals, jets, pillows, and other spa internals. Chemical abuse damage is not covered by this limited warranty, such damage to the spa can be avoided with proper maintenance of the spa waters chemistry.

Additional Disclaimers

Spa owners who have purchased a Cal Spa, and the spas final resting place is not in the United States or Canada, Cal Spas will be able to send components and parts directly to the spa customer if the original Cal Spa dealer is not within range of the spa. It is the responsibility of the spa owner to find a experienced electrician, plumber, or technician to perform the necessary repairs. A preliminary over the phone technical meeting with a Cal Spas representative is necessary, to ensure the experienced laborer is familiar with the spas operation, and recommended repair methods. Labor costs of a repair in such circumstances must be first approved by a Cal Spas representative, before moving forward with any repairs covered in this warranty. It is advised to request a labor quote from said experienced laborer, and to send this quote to a Cal Spas representative. If all prerequisites are met and the repair is approved, Cal Spas will reimburse the cost of labor directly to the spa owner upon completion of repairs. Reimbursements of charged labor will be sent as a check to the spa owners residence, with a varying estimated disbursement window.

For all repairs/warranty claims within the United States and Canada and other nations, it may be required to send parts/components back to Cal Spas when deemed necessary. In some circumstance where shipping the component/part is necessary, Cal Spas will provide a shipping label to send the affected or requested components/parts. It is the responsibility of the spa owner to properly package and secure the package for shipping. In some circumstances only images and proof of purchase would be necessary to file a warranty claim, in such circumstances if a Cal Spas representative deems that the parts do not have to be returned, follow all local regulations and laws to properly dispose of said components.



www.CalSpas.com

CONTACT INFORMATION

For customer service or service technicians, please contact your authorized dealer immediately. If you need additional information and/or assistance, contact

CAL SPAS

Lloyd's Material Supply Company, Inc.
Customer Service Department
1462 East Ninth Street, Pomona, CA 91766

Toll Free: 1-800-CAL-SPAS
Fax: 1-909-629-3890

LTR.2026.1010
3/16/2026 Rev E